

The logo for shopline SHOPFITTING is positioned on the right side of the page. The word "shopline" is written in a white, lowercase, sans-serif font. Below the "line" portion of "shopline", the word "SHOPFITTING" is written in a smaller, uppercase, sans-serif font, with each letter contained within a red rectangular box.

shopline
SHOPFITTING

shopline

SHOPFITTING

all in one

Shopfitting

Design

Production

Installation

We are a manufacturing company with more than 28 years of experience in retail industry. Our focus is solely on shopfitting. Combined with our comprehensive range of support services including consultancy, project management, design, you can relax knowing your project is in the right hands.

THE BEST
SOLUTION
FOR STORES



WALL SYSTEMS

- 08 Mesh System
- 18 Fix System
- 28 Basic System
- 38 Wall Up System
- 46 Point System
- 54 Wall Systems Equipment

60 DISPLAY STANDS

70 STORE EQUIPMENTS

76 ACCESSORIES

82 CASH DESKS

86 FITTING ROOM AREA



shopline

SHOPFITTING

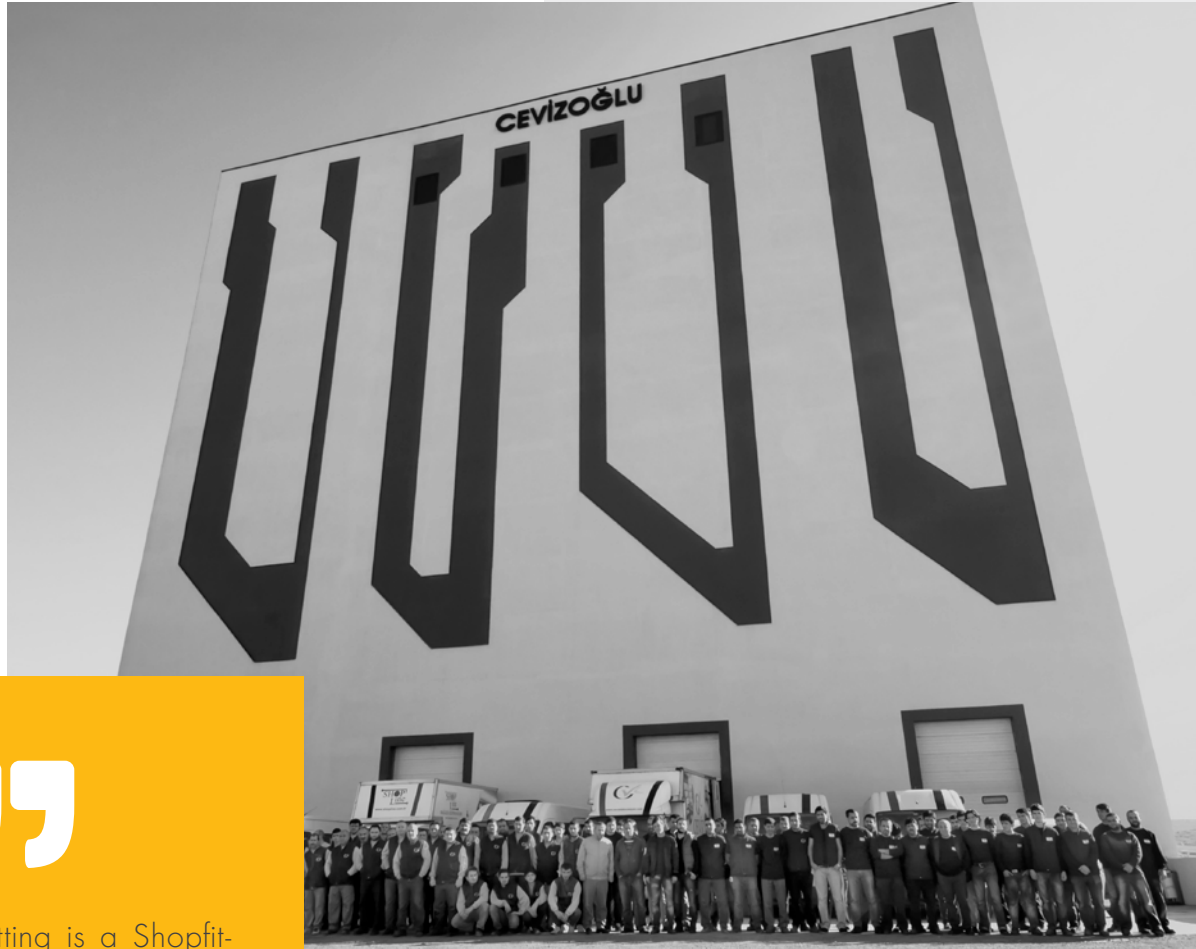

”

Shopline Shopfitting is a Shopfitting and Design company under the Cevizoglu Group. Established in 1991, Cevizoğlu Mağazacılık is a shopfitting company serving the retail industry. Doing business with passion and enthusiasm, Cevizoğlu executes projects and implements on schedule with over 200 personnel including professional design, project management, production and own installation team.

With over 28 years of experience in shopfitting with wood and metal manufacturing capabilities in an integrated 13,750sqm facility, Cevizoğlu has the ability to ship products worldwide from its 2500sqm warehouse that's a 3-hour-flight distance to over 60 countries.

Our Objectives

Shopline is a modular retail equipment system with an easy, standardized way. Also with the new custom-built design software, it allows customers to design their stores in the shortest time with a little effort. After this, customers have their modular products in the shortest time from our stocks. Thanks to its modularity, Shopline systems and display stands are delivered disassembled with minimum size. All units have assembly diagrams and videos so our customers install them without requiring professional support.



—
**more than
28 years of
experience...**

»» **Our Mission**

At Shopline, we provide easy access to store owners for innovation and design to create affordable and aesthetic retail environments.

»» **Our Vision**

To be the shopfitting company that provides the best solutions and to have the largest and happiest network.

shopline
SHOPFITTING

Shopfitting



**Project
Management**



**Concept
Creator**



Production

**Stock
&
Shipping**



**Service
&
Assembly**



ShopLine serves a wide range of customer portfolio from individual store owners to worldwide chain stores while keeping the design as the primary focus. Since design and production are made in the same kitchen, customers save time and money.

Our highly qualified and experienced team of craftsmen and project managers bring projects to life quickly and efficiently using the latest technology, delivering perfect finishes on time and within budget. They offer talent and style, ensuring your product not only reflects your brand values and personality, but remains uniquely eye-catching and memorable.



”

**YOUR SUCCESS IS
OUR GOAL**

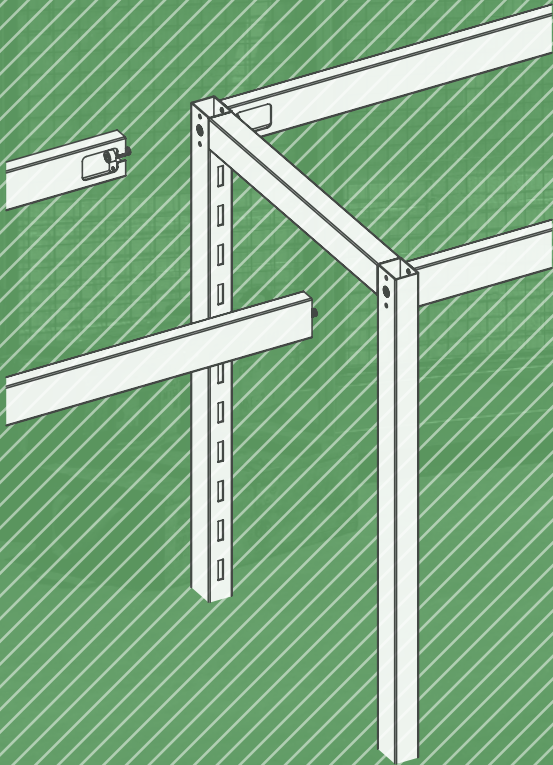
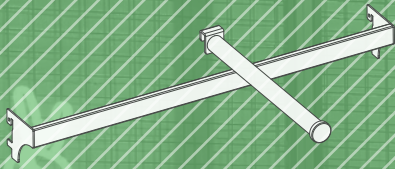
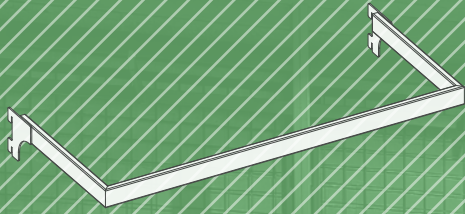
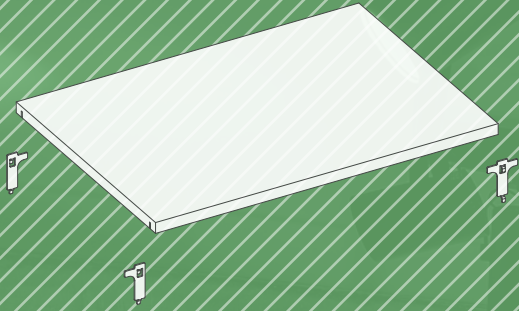

MESH SYSTEM

WALL SYSTEMS



Mesh System is a modular and self-standing store wall system created with frames and connectors. Mesh system allows you to create a 3D depth of space in your store. You can create excellent designs for your walls with the metal frame system. Since it is a freestanding wall system, it not only enables you to differentiate your concept but also provides alternative solutions by giving you opportunities to display your products in the middle of the store.



Use this QR code to get more detailed information about the system and the installation video.

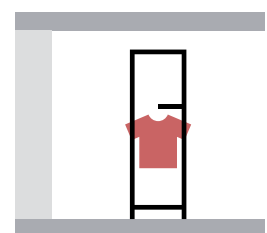
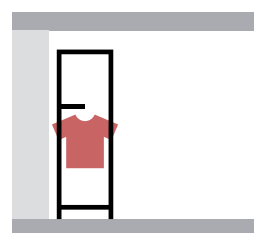
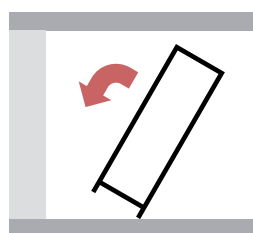

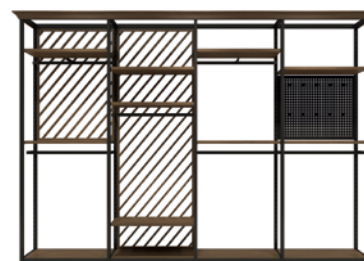
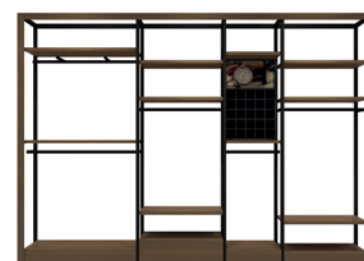
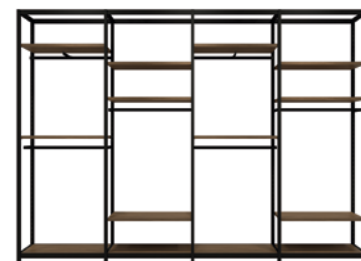
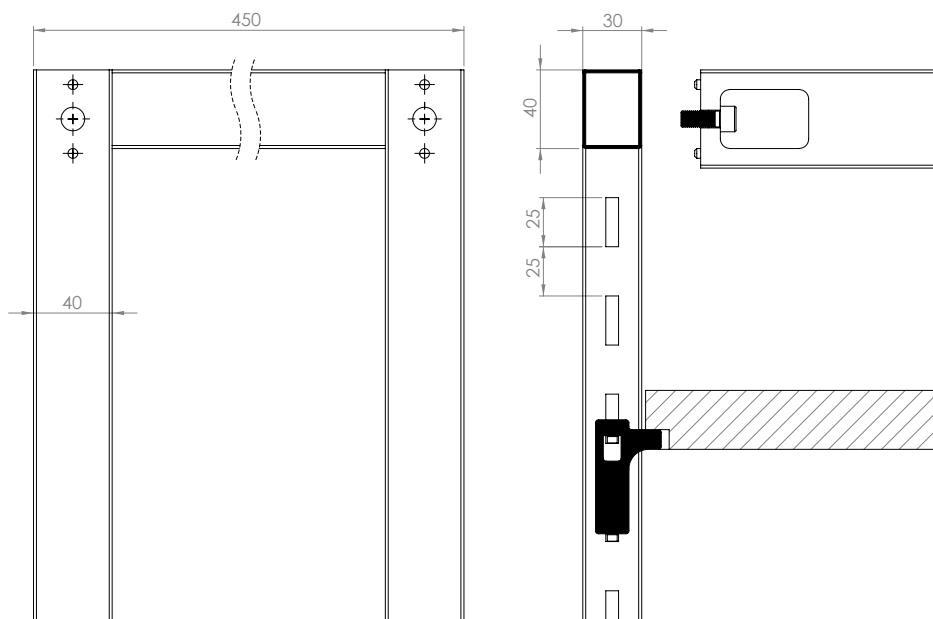

Mesh System, is a freestanding frame system which consists of 30x40 mm profile frames and 50x20 mm profile connectors.

We usually use this system placed in front of walls but of course you can use it as a center unit.

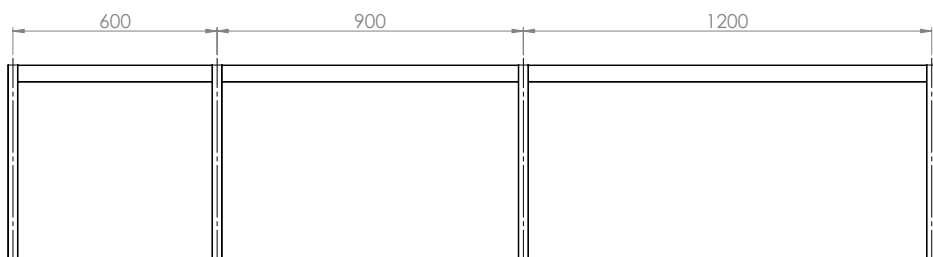



MS 01 - 2400 / P1
2700 / P1
3000 / P1

MESH SYSTEM FRAME

Materials :
metal

Dimensions :
450 x 2400 mm
450 x 2700 mm
450 x 3000 mm



MS 02 - T600 / P1
T900 / P1
T1200 / P1

MESH SYSTEM
TOP CONNECTOR

Materials :
metal

Dimensions :
574 mm
874 mm
1174 mm



MS 02 - B600 / P1
B900 / P1
B1200 / P1

MESH SYSTEM
BOTTOM CONNECTOR

Materials :
metal

Dimensions :
574 mm
874 mm
1174 mm



MS 03 - L / P1
MS 03 - M / P1
MS 03 - R / P1

MESH SYSTEM SHELF
BRACKET LEFT-MIDDLE-RIGHT

Materials :
metal

Dimensions :
-
-
-



MSS 01 - 6018 / SO
9018 / SO

MESH SYSTEM
18 mm SHELF

Materials :
melamine faced mdf

Dimensions :
570 x 425 x 18 mm
870 x 425 x 18 mm



MSS 02 - 6030 / SO
9030 / SO
12030 / SO

MESH SYSTEM
30 mm SHELF

Materials :
melamine faced chipboard

Dimensions :
570 x 425 x 30 mm
870 x 425 x 30 mm
1170 x 425 x 30 mm

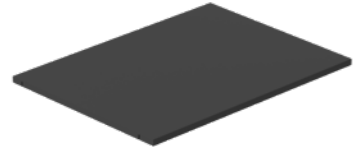

MSS 03 - 6030 / P1
9030 / P1
12030 / P1

MESH SYSTEM
SHEET METAL SHELF

Materials :
metal

Dimensions :
570 x 425 x 15 mm
870 x 425 x 15 mm
1170 x 425 x 15 mm

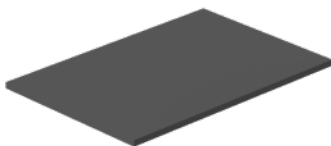

MSB 03 - 600 / P1
900 / P1
1200 / P1

MESH SYSTEM
SHEET METAL BASE COVER

Materials :
metal

Dimensions :
572 x 388 mm
872 x 388 mm
1172 x 388 mm



MST 03 - 600 / SO
900 / SO
1200 / SO

MESH SYSTEM TOP COVER

Materials :
melamine faced mdf

Dimensions :
590 x 410 x 30 mm
890 x 410 x 30 mm
1190 x 410 x 30 mm



MSB 01 - 600 / so
900 / so
1200 / so



MSB 02 - 6015 / so
9015 / so
12015 / so



MSB 02 - 6030 / so
9030 / so
12030 / so



MSB 02 - 6045 / so
9045 / so
12045 / so

MESH SYSTEM BASE COVER

Materials :
melamine faced mdf

Dimensions :
572 x 388 mm
872 x 388 mm
1172 x 388 mm

MESH SYSTEM HIGH BASE

Materials :
melamine faced mdf

Dimensions :
572 x 450 x 150 mm
872 x 450 x 150 mm
1172 x 450 x 150 mm

MESH SYSTEM HIGH BASE

Materials :
melamine faced mdf

Dimensions :
572 x 450 x 300 mm
872 x 450 x 300 mm
1172 x 450 x 300 mm

MESH SYSTEM HIGH BASE

Materials :
melamine faced mdf

Dimensions :
572 x 450 x 450 mm
872 x 450 x 450 mm
1172 x 450 x 450 mm



MST 02 - L6010 / so
L9010 / so
L12010 / so



MST 02 - M6010 / so
M9010 / so
M12010 / so



MST 02 - R6010 / so
R9010 / so
R12010 / so



MST 02 - R6010 / so
R9010 / so
R12010 / so

MESH SYSTEM
LEFT FRONT COVER

Materials :
melamine faced mdf

Dimensions :
619 x 100 mm
919 x 100 mm
1219 x 100 mm

MESH SYSTEM
MIDDLE FRONT COVER

Materials :
melamine faced mdf

Dimensions :
604 x 100 mm
904 x 100 mm
1204 x 100 mm

MESH SYSTEM
RIGHT FRONT COVER

Materials :
melamine faced mdf

Dimensions :
619 x 100 mm
919 x 100 mm
1219 x 100 mm

MESH SYSTEM
SINGLE FRONT COVER

Materials :
melamine faced mdf

Dimensions :
634 x 100 mm
934 x 100 mm
1234 x 100 mm

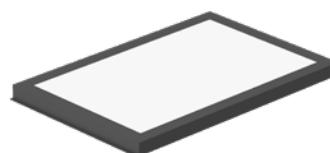

MST 01 - 600 / P1
900 / P1
1200 / P1

MESH SYSTEM
LIGHTNING PANEL

Materials :
metal & led

Dimensions :
572 x 388 x 30 mm
872 x 388 x 30 mm
1172 x 388 x 30 mm

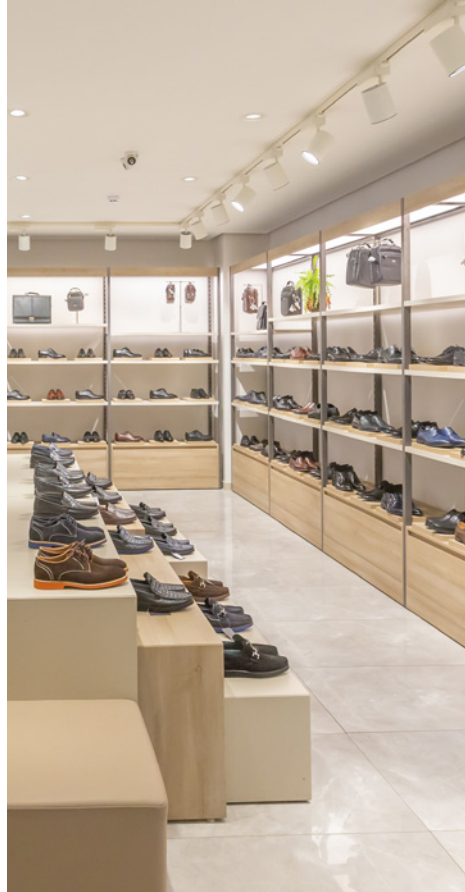







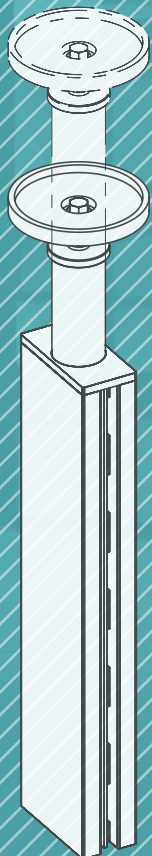
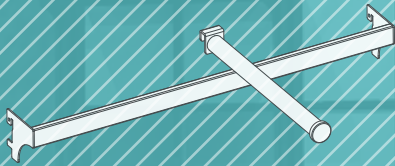
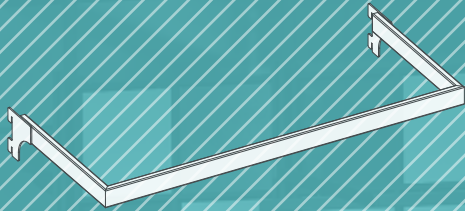
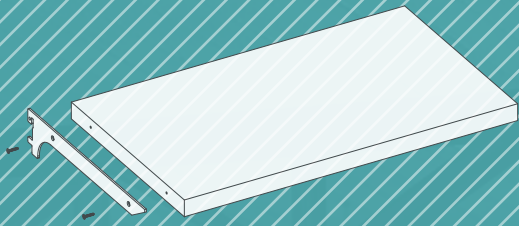



FIX
SYSTEM

WALL SYSTEMS



Fix system is a wall system consists of aluminum or iron uprights that can be height-adjusted. Fix System provides flexible solutions to your decoration needs thanks to its height-adjustable mechanism. Being independent of the back walls since the uprights are easily fixed to the floor and ceiling, the Fix system enables you to create more authentic designs. Moreover, it can be used as dividers in the middle of the stores as well as separators in front of the fitting rooms.



Use this QR code to get more detailed information about the system and the installation video.

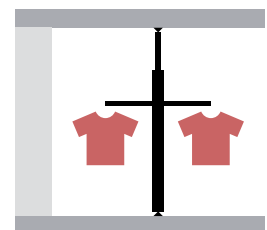
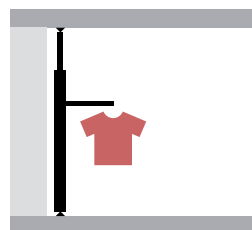
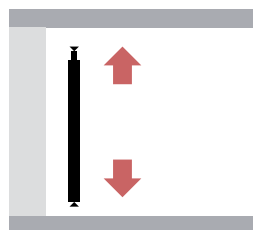

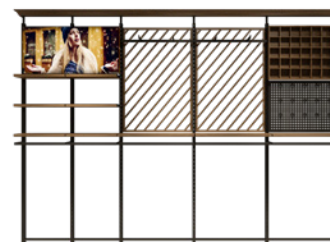
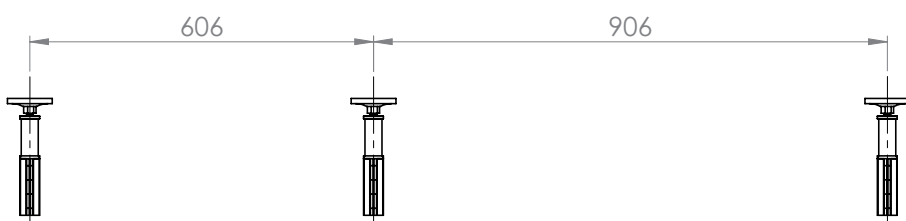
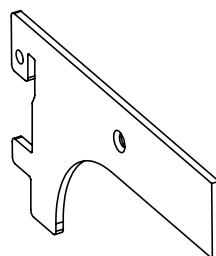
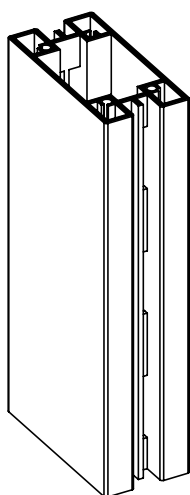
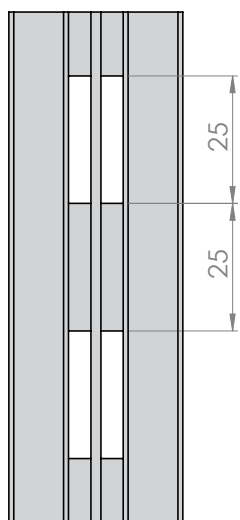
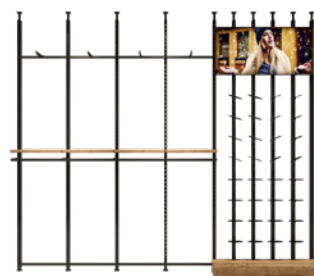
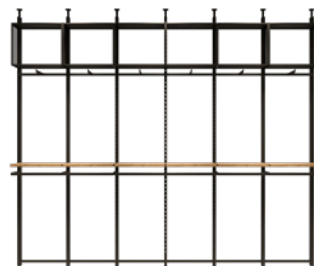
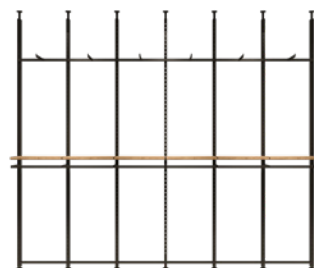
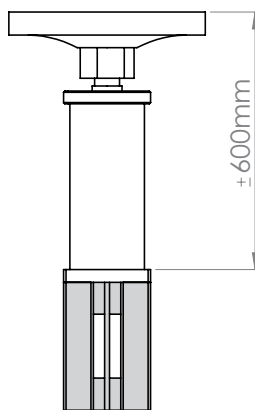
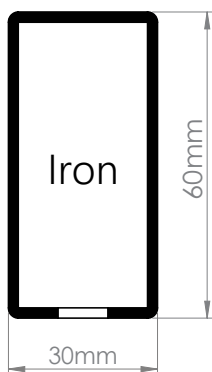
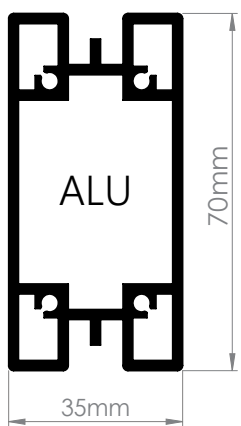





FX01A - **2400** / P1
2700 / P1
3000 / P1

FIX SYSTEM UPRIGHT

Materials :
 aluminium

Dimensions :
 2400 mm + 40 mm
 2700 mm + 40 mm
 3000 mm + 40 mm



FX01AT - **2400** / P1
2700 / P1
3000 / P1

FIX SYSTEM UPRIGHT WITH
 TELESCOPIC MECHANISM

Materials :
 aluminium

Dimensions :
 2400 mm + 600 mm
 2700 mm + 600 mm
 3000 mm + 600 mm

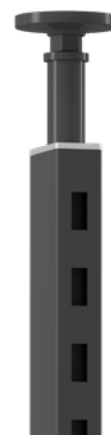

FX01DT - **2400** / P1
2700 / P1
3000 / P1

FIX SYSTEM UPRIGHT WITH
 TELESCOPIC MECHANISM

Materials :
 metal

Dimensions :
 2400 mm + 600 mm
 2700 mm + 600 mm
 3000 mm + 600 mm



FX03 - **2400** / SO
2700 / SO
3000 / SO

FIX SYSTEM UPRIGHT
 COVER

Materials :
 melamine faced mdf

Dimensions :
 2400 mm
 2700 mm
 3000 mm



FX02A - **600** / P1
900 / P1

FIX SYSTEM UPRIGHT
 CONNECTOR

Materials :
 aluminium

Dimensions :
 600 mm
 900 mm

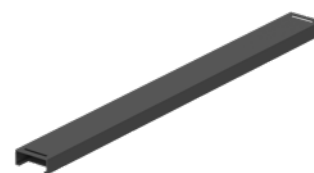

FX02D - **600** / P1
900 / P1

FIX SYSTEM UPRIGHT
 CONNECTOR

Materials :
 metal

Dimensions :
 600 mm
 900 mm









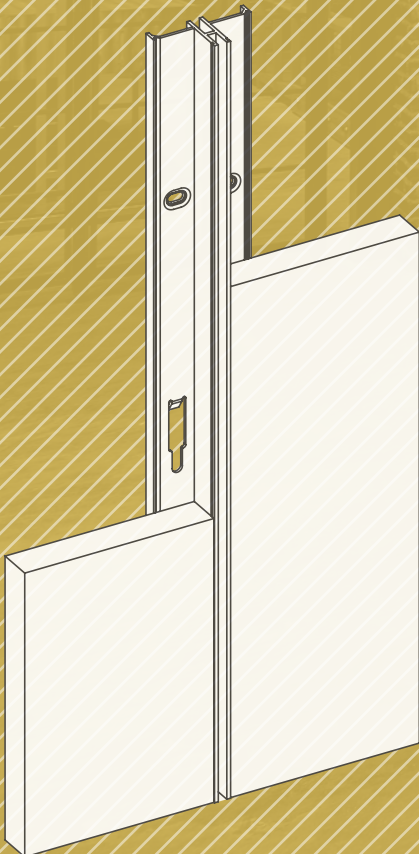
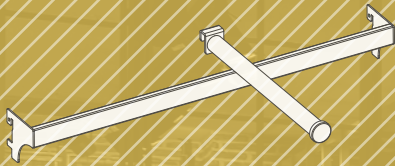
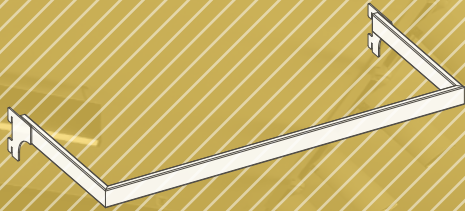
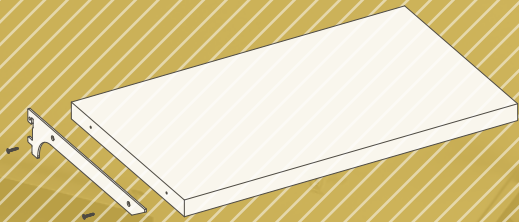

The image shows a wall-mounted storage system. At the top, a large rectangular panel with a grid of small holes is mounted. Several hooks are attached to this panel. Below the panel, there are four horizontal shelves of varying lengths, supported by vertical brackets. A small, round, woven basket sits on the top shelf. The background wall has a textured, stone-like appearance. The entire image is overlaid with a semi-transparent yellow filter.

BASIC

SYSTEM

WALL SYSTEMS



Basic System is an aluminum upright wall system with various decorative panel options. It is a wall system that can be used with 60 cm or 90 cm width panels. Shelves, hangers, front hangers, accessories display boxes, displays for ties and belts, illuminated visuals, storage boxes, and drawers can easily be used with the Basic System. You can display your products aesthetically with different color options.



Use this QR code to get more detailed information about the system and the installation video.

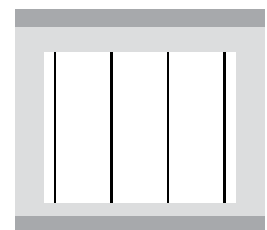
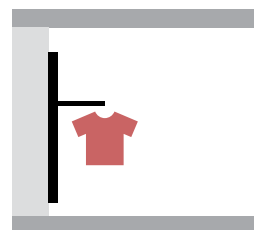
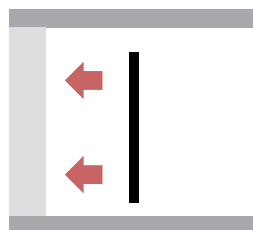

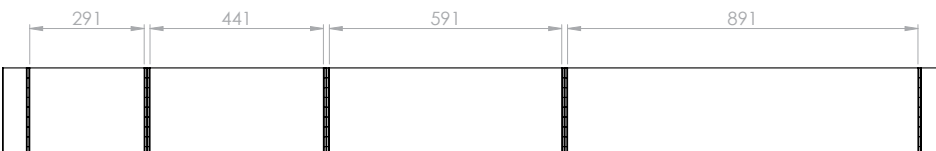
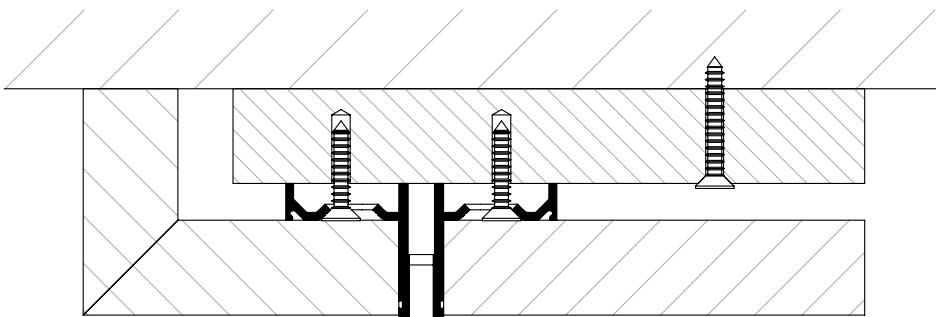
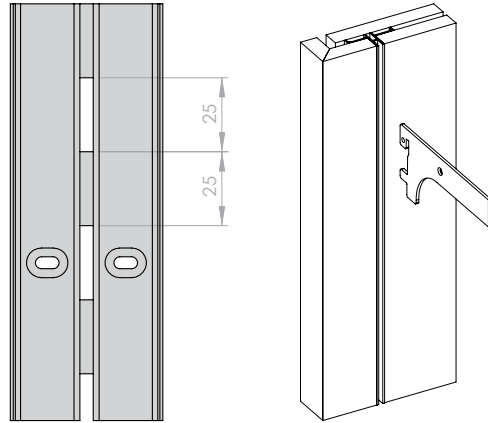
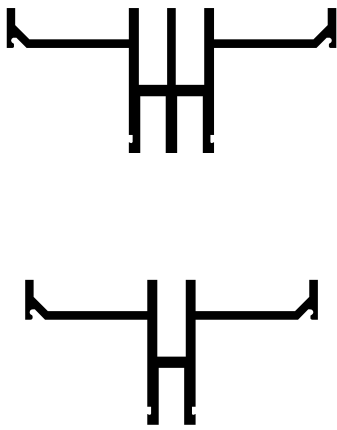



AP 01 - 2400 / A1
 2700 / A1
 3000 / A1

AP 01 - 2400 / P1
 2700 / P1
 3000 / P1

BASIC SYSTEM UPRIGHT
 SINGLE SLOTTED

Materials :
 aluminium

Dimensions :
 2400 mm
 2700 mm
 3000 mm

2400 mm
 2700 mm
 3000 mm



AP 02 - 2400 / A1
 2700 / A1
 3000 / A1

AP 02 - 2400 / P1
 2700 / P1
 3000 / P1

BASIC SYSTEM UPRIGHT
 DOUBLE SLOTTED

Materials :
 metal

Dimensions :
 2400 mm
 2700 mm
 3000 mm

2400 mm
 2700 mm
 3000 mm



BS 01 - L2400 / SO
 L2700 / SO
 L3000 / SO

BS 01 - R2400 / SO
 R2700 / SO
 R3000 / SO

BASIC SYSTEM
 LEFT - RIGHT SIDE COVER

Materials :
 melamine faced mdf

Dimensions :
 100 x 2400 x 43 mm
 100 x 2700 x 43 mm
 100 x 3000 x 43 mm



BP 01 - 60240 / WH
 60270 / WH
 60300 / WH

BP 01 - 90240 / WH
 90270 / WH
 90300 / WH

BASIC SYSTEM PANEL

Materials :
 melamine faced mdf

Dimensions :
 591 x 2400 mm
 591 x 2700 mm
 591 x 3000 mm

891 x 2400 mm
 891 x 2700 mm
 891 x 3000 mm



BP **02 - 60240** / WH
60270 / WH
60300 / WH

BP **03 - 60240** / SS
60270 / SS
60300 / SS

BP **04 - 60240** / SS
60270 / SS
60300 / SS

BP **05 - 60240** / WH
60270 / WH
60300 / WH

BP **02 - 90240** / WH
90270 / WH
90300 / WH

BP **03 - 90240** / SS
90270 / SS
90300 / SS

BP **04 - 90240** / SS
90270 / SS
90300 / SS

BP **05 - 90240** / WH
90270 / WH
90300 / WH

BASIC SYSTEM
 VERTICAL GROOVED PANEL

Materials :
 melamine faced mdf

Dimensions :
 591 x 2400 mm
 591 x 2700 mm
 591 x 3000 mm

891 x 2400 mm
 891 x 2700 mm
 891 x 3000 mm

BASIC SYSTEM HORIZONTAL
 GROOVED PANEL

Materials :
 melamine faced mdf

Dimensions :
 591 x 2400 mm
 591 x 2700 mm
 591 x 3000 mm

891 x 2400 mm
 891 x 2700 mm
 891 x 3000 mm

BASIC SYSTEM
 SQUARE FRAME PANEL

Materials :
 melamine faced mdf

Dimensions :
 591 x 2400 mm
 591 x 2700 mm
 591 x 3000 mm

891 x 2400 mm
 891 x 2700 mm
 891 x 3000 mm

BASIC SYSTEM
 STRIPED PANEL

Materials :
 melamine faced mdf

Dimensions :
 591 x 2400 mm
 591 x 2700 mm
 591 x 3000 mm

891 x 2400 mm
 891 x 2700 mm
 891 x 3000 mm









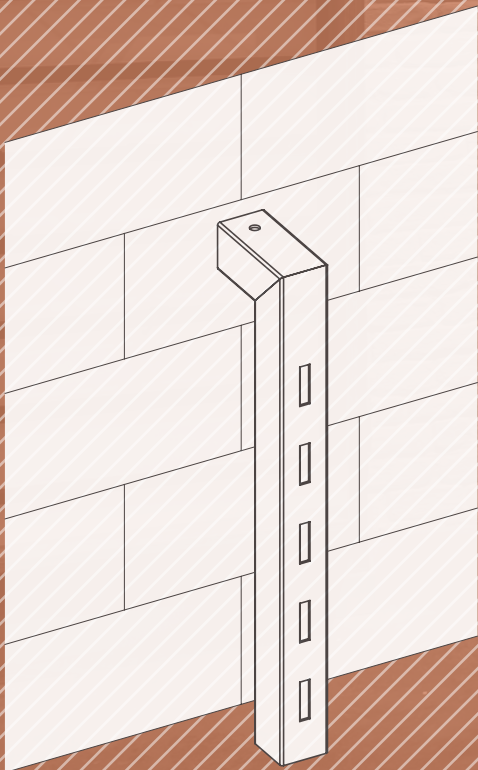
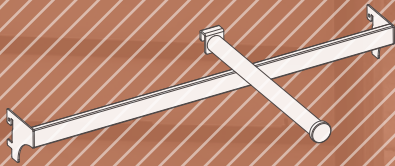
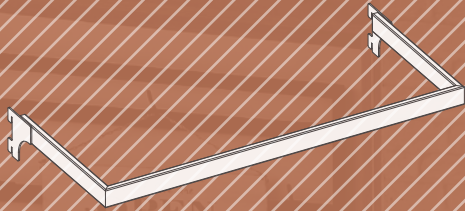
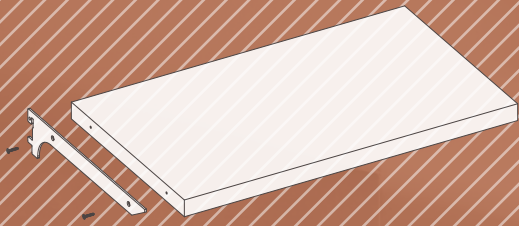

WALL UP

SYSTEM



WALL SYSTEMS



Wall Up system is a metal upright wall system mounted to the backwall on two points and to the floor on one point. It can be used with widths of 60cm, 90cm, and 120cm. It is an aesthetic, simple, functional and economical wall system that you can use in your stores. You can enhance the system with a variety of shelves, accessories panels, intermediate panels, illuminated visuals, front hangers, prongs, accessories display boxes and achieve attractive and stylish results.



Use this QR code to get more detailed information about the system and the installation video.

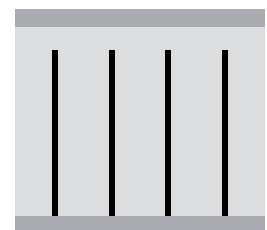
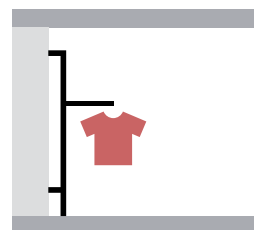
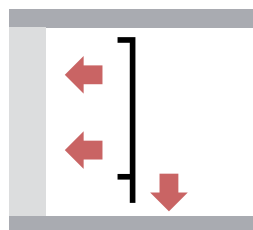

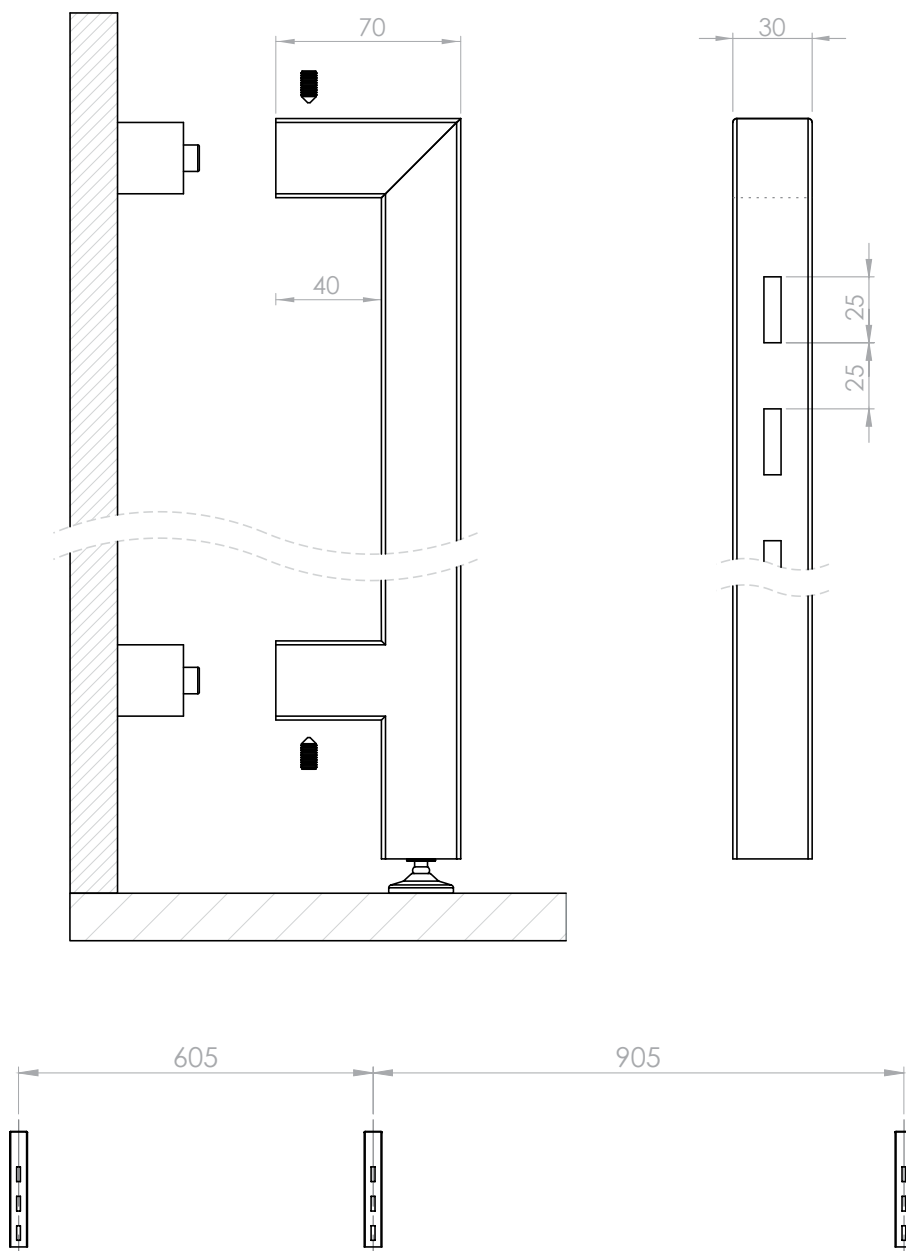

WLO1 - 2400 / P1
2700 / P1
3000 / P1

WALL UP SYSTEM
 METAL UPRIGHT

Materials :
 metal

Dimensions :
 2400 mm
 2700 mm
 3000 mm

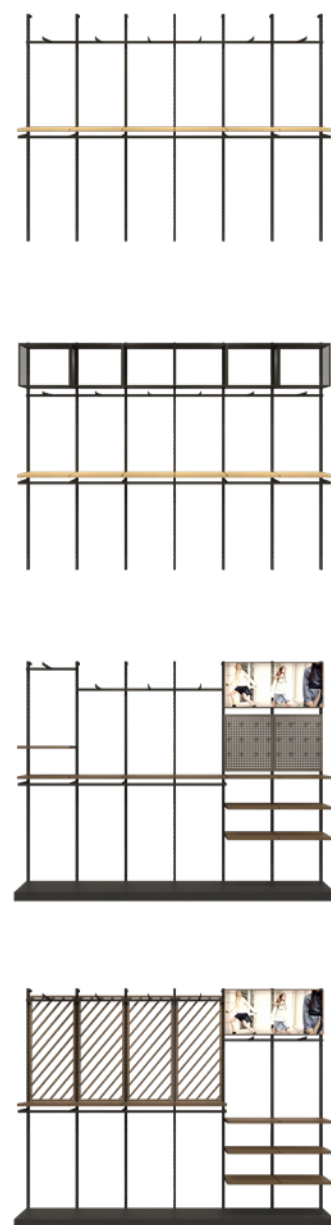









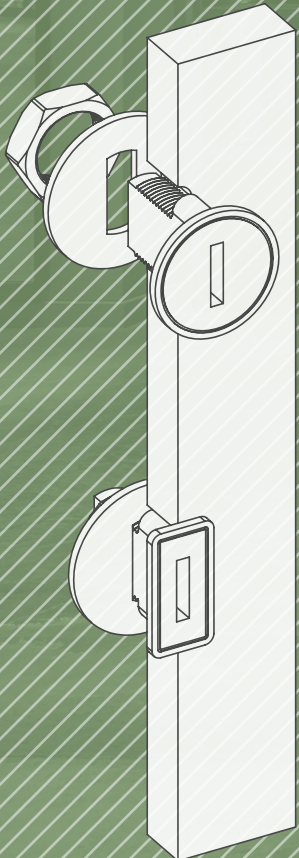
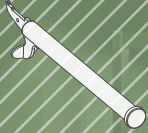
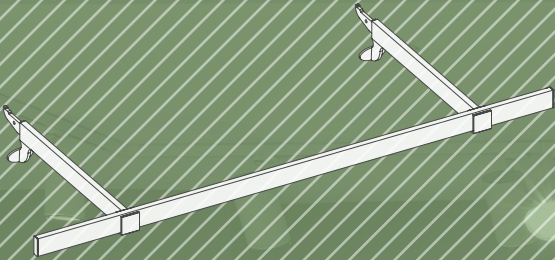
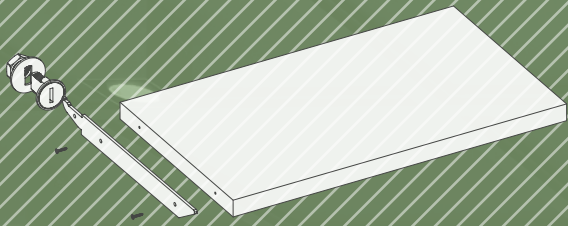



POINT SYSTEM

WALL SYSTEMS

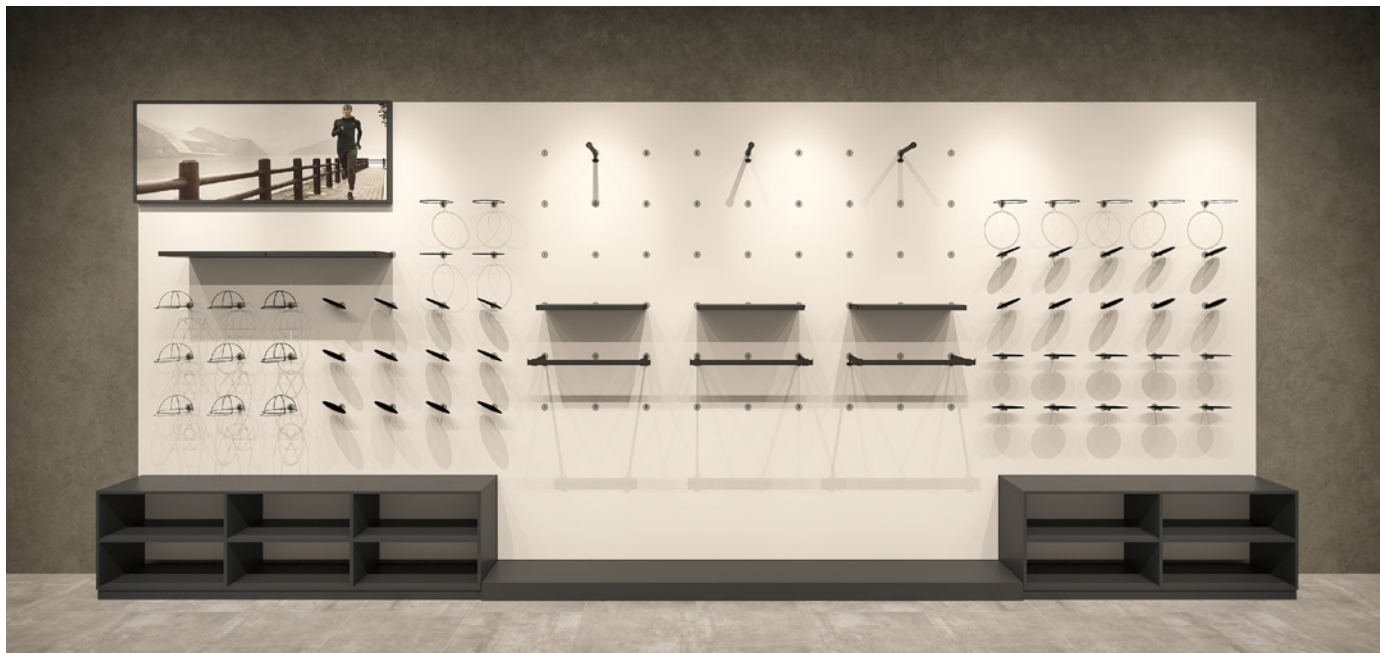

Point system is a wall system designed for single hanging needs with rectangular and circular puck designs that can be used on wooden panels of various colors. It offers practical solutions for functional and aesthetic requirements in your store. In particular, you can display individual shoes, hats, balls and apparel in a unique way and achieve a wide variety of display options with various accessories.



Use this QR code to get more detailed information about the system and the installation video.

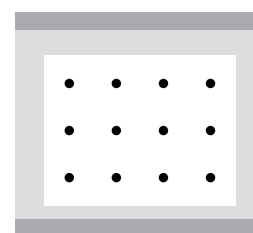
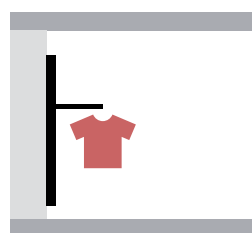
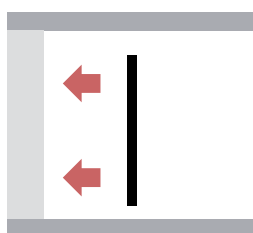

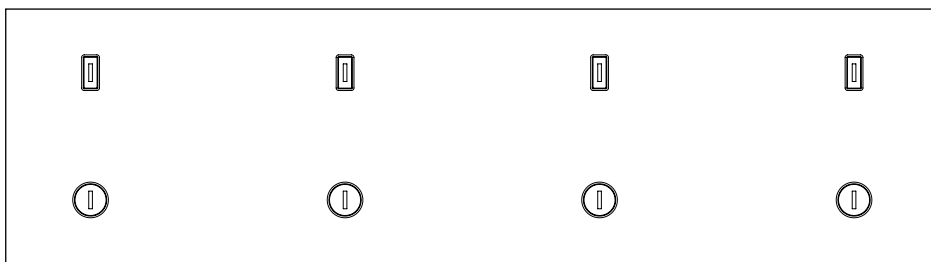
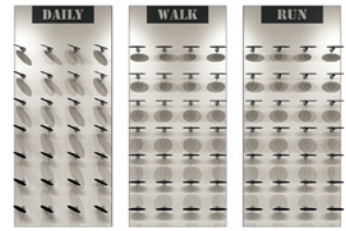
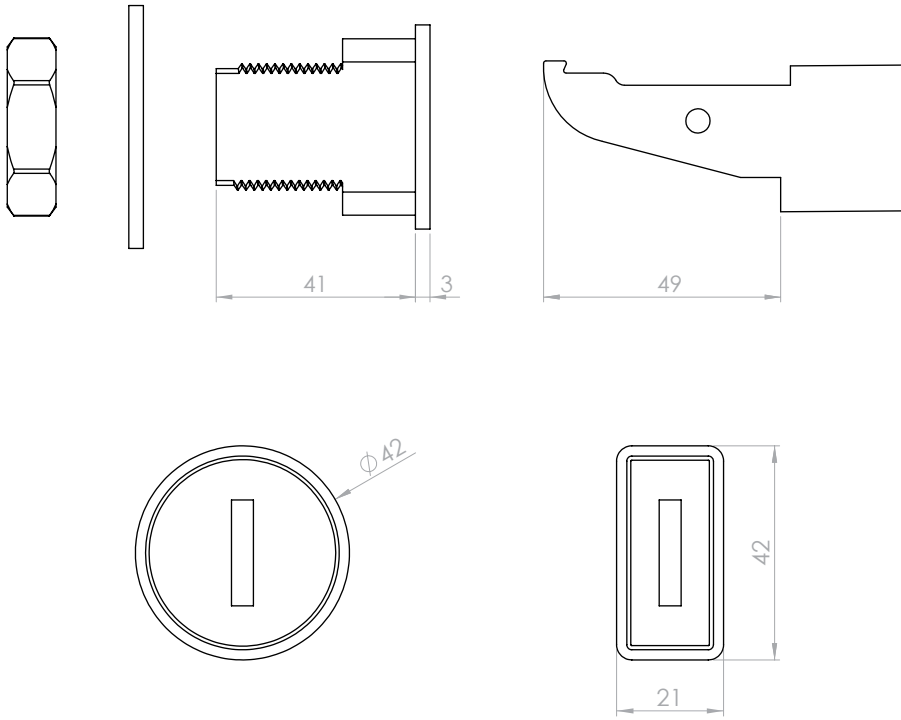



PS 01 / A1

CIRCULAR POINT SLOT

Materials :
metal

Dimensions :
ø 42 mm



PS 02 / A1

RECTANGULAR POINT SLOT

Materials :
metal

Dimensions :
21 x 42 mm



PS 03 - 290 / P1

SHELF BRACKET FOR 30 mm

Materials :
metal

Dimensions :
290 mm



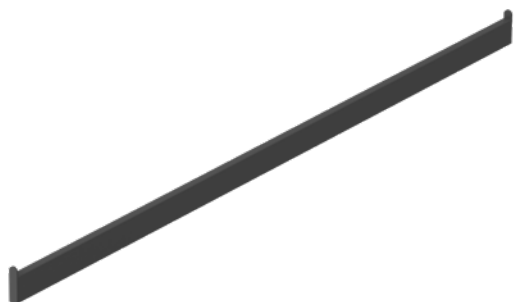

PS 05 - A900 / P1

HANGER PROFILE

Materials :
metal

Dimensions :
900 mm



PS 05 - B300 / P1

HANGER BRACKET

Materials :
metal

Dimensions :
300 mm



PS 04 - 300 / P1

TUBE FACEOUT

Materials :
metal

Dimensions :
300 mm



PS 07 - 300 / P1

ø10 mm STRAIGHT FACEOUT

Materials :
metal

Dimensions :
300 mm



PS 08 - 300 / P1

ANGLED FACEOUT

Materials :
metal

Dimensions :
300 mm



PS 09 - 300 / P1

STEPPED FACEOUT

Materials :
metal

Dimensions :
300 mm



PS 13 / P1

SHOE DISPLAY

Materials :
metal

Dimensions :
190 mm



PS 11 / P1

BALL DISPLAY

Materials :
metal

Dimensions :
ø 180 mm



PS 12 / P1

HAT DISPLAY

Materials :
metal

Dimensions :
ø 180 mm



PS 10 - 100 / P1

150 / P1

200 / P1

250 / P1

HOOK

Materials :
metal

Dimensions :
100 mm
150 mm
200 mm
250 mm





EQUIPMENT

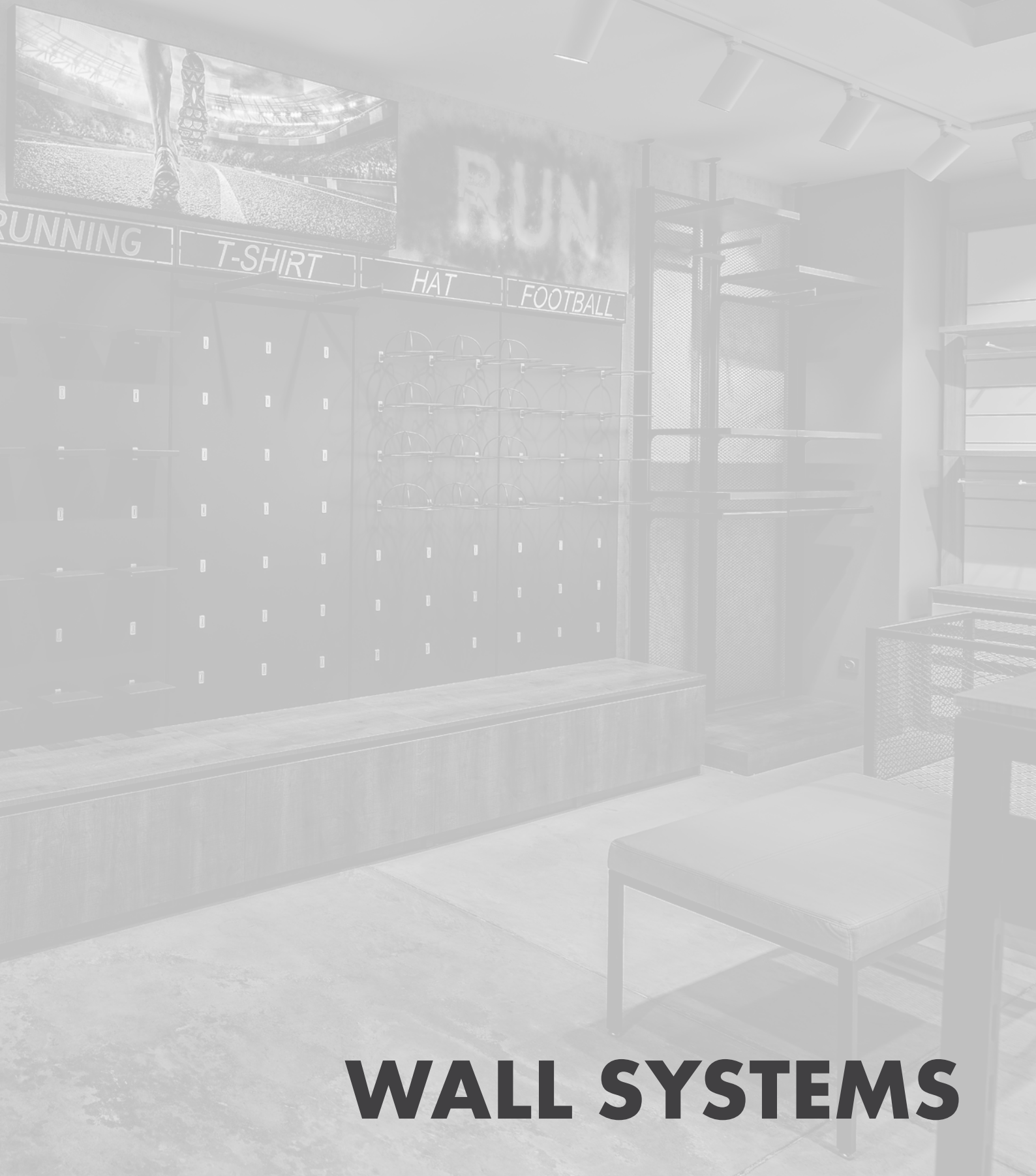

WALL SYSTEMS



MP 01 - 290 / P1

SHELF BRACKET
FOR 30 mm

Materials :
metal

Dimensions :
290 mm



MP 02 - 340 / P1

ANGLED SHELF BRACKET
FOR 30 mm

Materials :
metal

Dimensions :
340 mm



MP 03 - L290 / P1

LEFT L SHELF BRACKET
FOR 18 mm

Materials :
metal

Dimensions :
290 mm



MP 03 - R290 / P1

RIGHT L SHELF BRACKET
FOR 18 mm

Materials :
metal

Dimensions :
290 mm



MP 10 - C / P1

BRACKET FOR
HANGER PROFILE

Materials :
metal

Dimensions :
-



MP 10 - B300 / P1

HANGER BRACKET

Materials :
metal

Dimensions :
300 mm

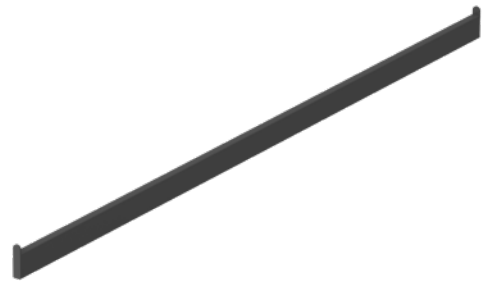

MP 10 - A900 / P1
A1200 / P1

HANGER PROFILE

Materials :
metal

Dimensions :
900 mm
1200 mm

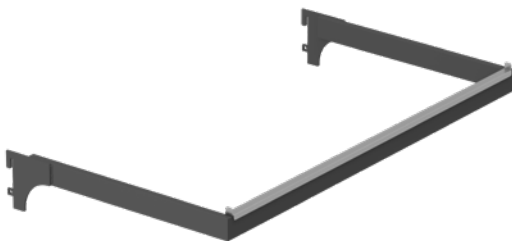

MP 11 - 600 / P1
900 / P1
1200 / P1

U HANGER

Materials :
metal

Dimensions :
600 mm
900 mm
1200 mm

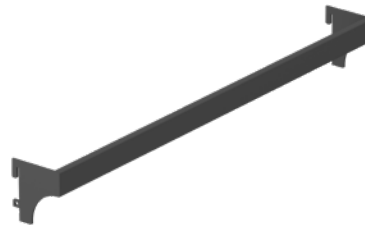

MP 13 - 600 / P1
900 / P1
1200 / P1

SHORT U HANGER

Materials :
metal

Dimensions :
600 mm
900 mm
1200 mm



MP 06 - 300 / P1

TUBE FACEOUT

Materials :
metal

Dimensions :
300 mm

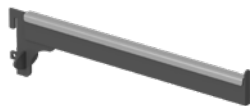

MP 07 - 300 / P1

RECTANGLE FACEOUT

Materials :
metal

Dimensions :
300 mm



MP 08 - 350 / P1

RECTANGLE
STEPPED FACEOUT

Materials :
metal

Dimensions :
350 mm



MP 14 - 300 / P1

∅ 10 STRAIGHT FACEOUT

Materials :
metal

Dimensions :
300 mm



MP 15 - 300 / P1

ANGLED FACEOUT

Materials :
metal

Dimensions :
300 mm



MP 16 - 300 / P1

STEPPED FACEOUT

Materials :
metal

Dimensions :
300 mm



MP 18 / P1

SHOE DISPLAY

Materials :
metal

Dimensions :
190 mm



MP 17 - L / P1

RIGHT GLASS SHELF BRACKET

Materials :
metal

Dimensions :
-



MP 17 - R / P1

LEFT GLASS SHELF BRACKET

Materials :
metal

Dimensions :
-



SP 01 / A1

HORIZONTAL PROFILE

Materials :
aluminium

Dimensions :
1000 mm



SP 02 - 290 / P1

SHELF BRACKET FOR 30 mm

Materials :
metal

Dimensions :
290 mm

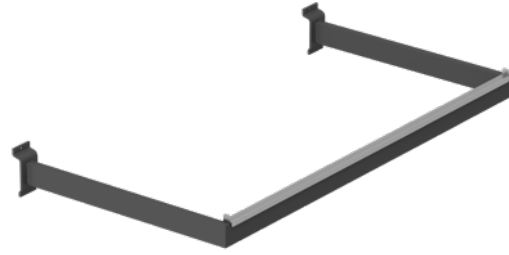

SP 06 - 600 / P1

U HANGER

Materials :
metal

Dimensions :
600 mm



SP 07 - 300 / P1

∅ 10 mm STRAIGHT FACEOUT

Materials :
metal

Dimensions :
300 mm



SP 08 - 300 / P1

ANGLED FACEOUT

Materials :
metal

Dimensions :
300 mm

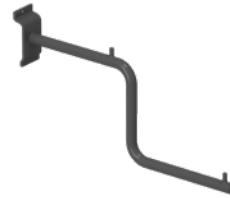

SP 09 - 300 / P1

STEPPED FACEOUT

Materials :
metal

Dimensions :
300 mm



SP 10 - 100 / P1

150 / P1

200 / P1

250 / P1

HOOK

Materials :
metal

Dimensions :
100 mm
150 mm
200 mm
250 mm



SP 11 / P1

BALL DISPLAY

Materials :
metal

Dimensions :
∅ 180 mm



SP 12 / P1

HAT DISPLAY

Materials :
metal

Dimensions :
∅ 180 mm

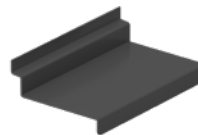

SP 13 / P1

SHOE DISPLAY

Materials :
metal

Dimensions :
190 mm

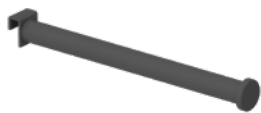

AP 12 - 300 / P1

HOOKED TUBE
FACEOUT

Materials :
metal

Dimensions :
300 mm

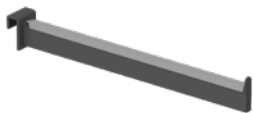

AP 13 - 300 / P1

HOOKED RECTANGLE
FACEOUT

Materials :
metal

Dimensions :
300 mm

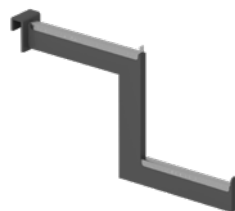

AP 14 - 350 / P1

HOOKED RECTANGLE
STEPPED FACEOUT

Materials :
metal

Dimensions :
350 mm

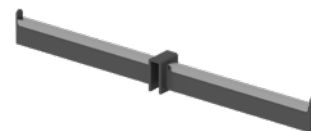

AP 15 - 400 / P1

HOOKED RECTANGLE
DOUBLE WAY FACEOUT

Materials :
metal

Dimensions :
400 mm



AP 05 - 300 / P1

∅ 10 mm HOOKED
STRAIGHT FACEOUT

Materials :
metal

Dimensions :
300 mm



AP 06 - 300 / P1

HOOKED ANGLED FACEOUT

Materials :
metal

Dimensions :
300 mm



AP 07 - 300 / P1

HOOKED STEPPED FACEOUT

Materials :
metal

Dimensions :
300 mm



AP 08 - 100 / P1
150 / P1
200 / P1
250 / P1

HOOK

Materials :
metal

Dimensions :
100 mm
150 mm
200 mm
250 mm



AP 09 / P1

HOOKED BALL DISPLAY

Materials :
metal

Dimensions :
∅ 180 mm



AP 10 / P1

HOOKED HAT DISPLAY

Materials :
metal

Dimensions :
∅ 180 mm



AP 11 / P1

HOOKED SHOE DISPLAY

Materials :
metal

Dimensions :
190 mm



DISPLAY STANDS





SHL 101 / P1 - SO

SERVICE TABLE
WITH GLASS TOP & SHELF

Materials :
glass, metal & melamine faced mdf

Dimensions :
800 x 1600 x 800 mm



SHL 102 / P1 - SO

SERVICE TABLE
WITH 4 SHELVES

Materials :
metal & melamine faced mdf

Dimensions :
800 x 1600 x 800 mm



SHL 105 / P1 - SO

NESTING TABLE
WITH UNDER UNIT

Materials :
metal & melamine faced mdf

Dimensions :
800 x 1600 x 800 mm
620 x 1400 x 593 mm



SHL 111 / P1 - SO

DISPLAY STAND
WITH 3 SHELVES & HANGER

Materials :
metal & melamine faced mdf

Dimensions :
500 x 1225 x 1250 mm



SHL 103 / P1 - SO

NESTING TABLE
WITH 2 SMALL TABLES

Materials :
metal & melamine faced mdf

Dimensions :
800 x 1600 x 800 mm
400 x 1400 x 440 mm



SHL 104 / P1 - SO

NESTING TABLE
WITH 2 CABINET

Materials :
metal & melamine faced mdf

Dimensions :
800 x 1600 x 800 mm
400 x 1400 x 450 mm



SHL 121 / P1 - SO

NESTING TABLE
WITH SMALL TABLE & BOX UNIT

Materials :
metal & melamine faced mdf

Dimensions :
800 x 1600 x 800 mm
400 x 1400 x 600 mm
450 x 1200 x 370 mm



SHL 131 / SO

NESTING TABLE
WITH SMALL TABLE & BASE UNIT

Materials :
melamine faced mdf

Dimensions :
800 x 1600 x 800 mm
400 x 1400 x 600 mm
400 x 1300 mm



SHL 141 / P1 - SO

SERVICE TABLE WITH 2 SHELVES

Materials :
metal & melamine faced mdf

Dimensions :
1800 x 800 x 800 mm



SHL 201 / P1 - SO

HANGER STAND

Materials :
metal & melamine faced mdf

Dimensions :
500 x 1200 x 1200 mm + 600 mm

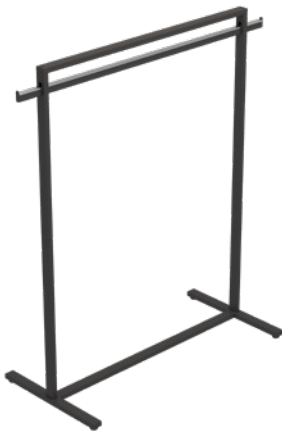

SHL 231 / P1

HANGER STAND

Materials :
metal

Dimensions :
500 x 1300 x 1400 mm



SHL 301 / P1

4 WAY HANGER

Materials :
metal

Dimensions :
940 x 940 x 1200 mm + 600 mm



SHL 211 / P1 - SO

DOUBLE HANGER STAND

Materials :
metal & melamine faced mdf

Dimensions :
500 x 1200 x 1350 mm



SHL 221 / P1 - SO

HANGER STAND WITH 3 SHELVES

Materials :
metal & melamine faced mdf

Dimensions :
500 x 1300 x 1250 mm



SHL 302 / P1 - SO

4 WAY HANGER WITH BASE

Materials :
metal & melamine faced mdf

Dimensions :
650 x 650 x 1250 mm + 600 mm



SHL 311 / P1 - SO

2 WAY HANGER

Materials :
metal & melamine faced mdf

Dimensions :
500 x 700 x 1200 mm + 600 mm



SHL 321 / P1 - SO

3 WAY HANGER

Materials :
metal & melamine faced mdf

Dimensions :
500 x 850 x 1200 mm + 600 mm



SHL 401 / P1 - SO

BASKET WITH METAL MESH

Materials :

metal & melamine faced mdf

Dimensions :

800 x 800x 900 mm



SHL 402 / P1 - SO

BASKET WITH METAL GRID

Materials :

metal & melamine faced mdf

Dimensions :

800 x 800 x 900 mm



SHL 411 / P1 - SO

BASKET WITH METAL MESH

Materials :

metal & melamine faced mdf

Dimensions :

800 x 800x 900 mm



SHL 412 / P1 - SO

BASKET WITH METAL GRID

Materials :

metal & melamine faced mdf

Dimensions :

800 x 800 x 900 mm



SHL 403 / P1 - SO

BASKET WITH POLYCARBON PANEL

Materials :
metal & melamine faced mdf

Dimensions :
800 x 800 x 900 mm



SHL 404 / P1 - SO

BASKET WITH WOODEN PANEL

Materials :
metal & melamine faced mdf

Dimensions :
800 x 800 x 900 mm



SHL 413 / P1 - SO

BASKET WITH POLYCARBON PANEL

Materials :
metal & melamine faced mdf

Dimensions :
800 x 800 x 900 mm



SHL 414 / P1 - SO

BASKET WITH WOODEN PANEL

Materials :
metal & melamine faced mdf

Dimensions :
800 x 800 x 900 mm

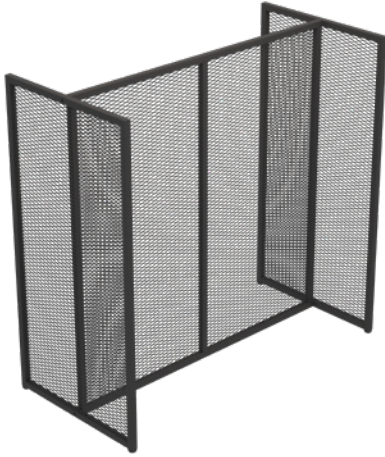

SHL 501 / P1

MODULAR STAND WITH METAL MESH

Materials :

metal

Dimensions :

625 x 1285 x 1225 mm

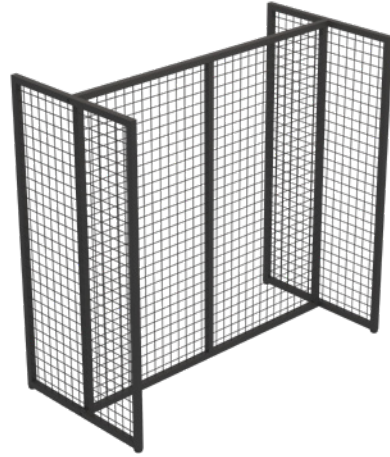

SHL 502 / P1

MODULAR STAND WITH METAL GRID

Materials :

metal

Dimensions :

625 x 1285 x 1225 mm



SHL 601 / P1 - SO

ACCESSORIES DISPLAY STAND
WITH METAL MESH

Materials :

metal & melamine faced mdf

Dimensions :

500 x 620 x 1340 mm

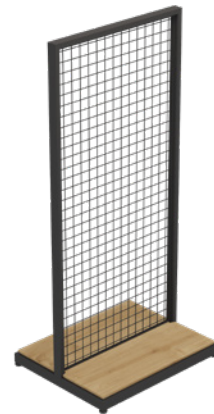

SHL 602 / P1 - SO

ACCESSORIES DISPLAY STAND
WITH METAL GRID

Materials :

metal & melamine faced mdf

Dimensions :

500 x 620 x 1340 mm

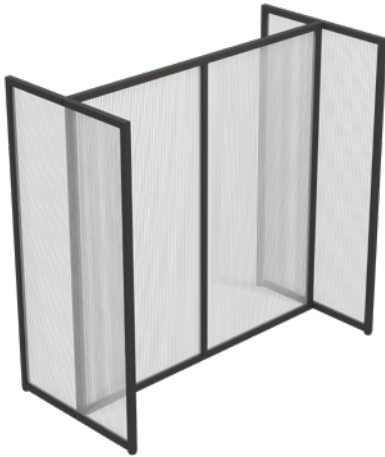

SHL 503 / P1

MODULAR STAND WITH POLYCARBON PANEL

Materials :
metal & polycarbon

Dimensions :
625 x 1285 x 1225 mm



SHL 504 / P1 - SO

MODULAR STAND WITH WOODEN PANEL

Materials :
metal & melamine faced mdf

Dimensions :
625 x 1285 x 1225 mm



SHL 603 / P1 - SO

ACCESSORIES DISPLAY STAND
WITH POLYCARBON PANEL

Materials :
metal & melamine faced mdf

Dimensions :
500 x 620 x 1340 mm



SHL 604 / P1 - SO

ACCESSORIES DISPLAY STAND
WITH WOODEN PANEL

Materials :
metal & melamine faced mdf

Dimensions :
500 x 620 x 1340 mm

STORE EQUIPMENT





SF 01 - 6018 / SO
9018 / SO

18 mm SHELF

Materials :
melamine faced mdf

Dimensions :
596 x 350 x 18 mm
896 x 350 x 18 mm

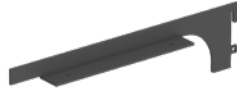

MP 03 - L290 / P1
LEFT L SHELF BRACKET
FOR 18 mm

Materials :
metal

Dimensions :
290 mm



MP 03 - R290 / P1
RIGHT L SHELF BRACKET
FOR 18 mm

Materials :
metal

Dimensions :
290 mm



SF 02 - 6030 / SO
9030 / SO
12030 / SO

30 mm SHELF

Materials :
melamine faced chipboard

Dimensions :
596 x 350 x 30 mm
896 x 350 x 30 mm
1196 x 350 x 30 mm



MP 01 - 290 / P1
SHELF BRACKET FOR 30 mm

Materials :
metal

Dimensions :
290 mm



MP 02 - 290 / P1
ANGLED SHELF BRACKET
FOR 30 mm

Materials :
metal

Dimensions :
290 mm



SF 03 - 6015 / P1
9015 / P1

SHEET METAL SHELF

Materials :
metal

Dimensions :
596 x 350 x 15 mm
896 x 350 x 15 mm



EQ 01 - 4510 / SO

BASE FOR WALL SYSTEM

Materials :
melamine faced mdf

Dimensions :
450 x 1000 x 100 mm



EQ 11 - 8010 / SO
9010 / SO

BASE FOR WINDOW

Materials :
melamine faced mdf

Dimensions :
800 x 1000 x 100 mm
900 x 1000 x 100 mm



EQ 21 - 6015 / SO
6030 / SO
6045 / SO

MANNEQUIN PLATFORM

Materials :
melamine faced mdf

Dimensions :
600 x 600 x 150 mm
600 x 600 x 300 mm
600 x 600 x 450 mm



EQ 71 / P1

LABEL HOLDER WITH BASE

Materials :
metal

Dimensions :
215 x 150 x 350 mm



EQ 72 / P1

ADJUSTABLE
LABEL HOLDER WITH BASE

Materials :
metal

Dimensions :
215 x 150 x 350 mm + 110 mm



EQ 73 / P1

LABEL HOLDER
FOR DISPLAY STAND

Materials :
metal

Dimensions :
215 x 75 x 180 mm



EQ 74 / P1

LABEL HOLDER WITH BASE

Materials :
metal

Dimensions :
301 x 150 x 201 mm



EQ 75 / P1

HIGH LABEL
HOLDER WITH BASE

Materials :
metal

Dimensions :
301 x 150 x 350 mm



EQ 81 / P1

ADJUSTABLE DOUBLE
SIDED BAG HOLDER

Materials :
metal

Dimensions :
200 x 200 x 300 mm + 200 mm



EQ 82 / P1

ADJUSTABLE SINGLE
SIDED BAG HOLDER

Materials :
metal

Dimensions :
200 x 200 x 300 mm + 200 mm



EQ 91 - A5
EQ 91 - A4
EQ 91 - A3

ACRYLIC PRICE
TAG HOLDER

Materials :
acrylic

Dimensions :
148 x 210 x 3 mm
210 x 297 x 3 mm
297 x 420 x 3 mm



EQ 22 - 6015 / P1 - SO
6030 / P1 - SO
6045 / P1 - SO

MANNEQUIN PLATFORM
WITH METAL PROFILE

Materials :
metal & melamine faced mdf

Dimensions :
600 x 600 x 150 mm
600 x 600 x 300 mm
600 x 600 x 450 mm



EQ 31 - 6045 / SO
9045 / SO
12045 / SO

STORAGE CABINET
WITH DOOR FOR
FRONT OF THE SYSTEM

Materials :
melamine faced mdf

Dimensions :
605 x 450 x 450 mm
905 x 450 x 450 mm
1205 x 450 x 450 mm



EQ 32 - 6045 / SO
9045 / SO
12045 / SO

STORAGE CABINET
WITH DOOR FOR
BETWEEN UPRIGHTS

Materials :
melamine faced mdf

Dimensions :
570 x 450 x 450 mm
870 x 450 x 450 mm
1170 x 450 x 450 mm



EQ 61 - 5050 / P1 - FLG
EQ 61 - 50120 / P1 - FLG

FABRIC STOOL WITH
METAL LEGS

Materials :
fabric & metal

Dimensions :
500 x 500 x 450 mm
500 x 1200 x 450 mm



EQ 41 - 60220 / SO
60240 / SO
90220 / SO
90240 / SO

EQ 42 - 60220 / A1
60240 / A1
90220 / A1
90240 / A1

EQ 52 - 60220 / SO
60240 / SO
90220 / SO
90240 / SO

EQ 53 - 60220 / A1
60270 / A1
90220 / A1
90240 / A1

WOODEN
FRAMED MIRROR

ALUMINIUM
FRAMED MIRROR

WOODEN FRAMED
ACCESSORIES PANEL

ALUMINIUM FRAMED
ACCESSORIES PANEL

Materials :
mirror & melamine faced mdf

Materials :
mirror & aluminium

Materials :
aluminium profile &
melamine faced mdf

Materials :
aluminium profile & aluminium &
melamine faced mdf

Dimensions :
600 x 2200 mm
600 x 2400 mm

Dimensions :
600 x 2200 mm
600 x 2400 mm

Dimensions :
600 x 2200 mm
600 x 2400 mm

Dimensions :
600 x 2200 mm
600 x 2400 mm

900 x 2200 mm
900 x 2400 mm

900 x 2200 mm
900 x 2400 mm

900 x 2200 mm
900 x 2400 mm

900 x 2200 mm
900 x 2400 mm



EQ 54 - 60210 / P1
60230 / P1
90210 / P1
90230 / P1

METAL
ACCESSORIES PANEL

Materials :
metal

Dimensions :
600 x 2100 mm
600 x 2300 mm

900 x 2100 mm
900 x 2300 mm



EQ 55 - 60210 / P1 - SO
60230 / P1 - SO
90210 / P1 - SO
90230 / P1 - SO

METAL ACCESSORIES PANEL
WITH WOODEN BOX

Materials :
metal & melamine faced mdf

Dimensions :
720 x 2200 x 120 mm
720 x 2400 x 120 mm

1020 x 2200 x 120 mm
1020 x 2400 x 120 mm



EQ 51 - 60240 / SO
90240 / SO

ACCESSORIES CABINET

Materials :
metal & melamine faced mdf

Dimensions :
600 x 2400 mm
900 x 2400 mm

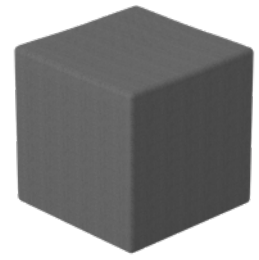

EQ 62 - 5050 / FLG

FABRIC
CUBE STOOL

Materials :
fabric & metal

Dimensions :
500 x 500 x 450 mm

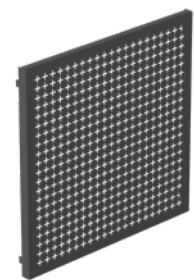

EQ 56 - 6060 / P1
6090 / P1
9090 / P1

SHEET METAL
ACCESSORIES PANEL

Materials :
metal

Dimensions :
600 x 600 mm
600 x 900 mm
900 x 900 mm



EQ 57 - H100 / P1
H150 / P1
H200 / P1
H250 / P1

HOOK FOR SHEET METAL
ACCESSORIES PANEL

Materials :
metal

Dimensions :
100 mm
150 mm
200 mm
250 mm



Değerli Müşterimiz

KOTON

GRUBU
KARTI BANKA GELİ
6 AYLIK TAKİT



Access

ACCESSORIES

ssories





AC 01 - 6040 / P1 - SO
9040 / P1 - SO

PROFILE FRAMED BOX SHELF

Materials :
metal & melamine faced mdf

Dimensions :
600 x 300 x 400 mm
900 x 300 x 400 mm

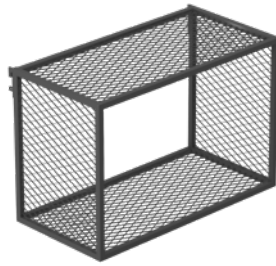

AC 02 - 6040 / P1
9040 / P1

PROFILE FRAMED BOX SHELF
WITH MESH METAL

Materials :
metal

Dimensions :
600 x 300 x 400 mm
900 x 300 x 400 mm

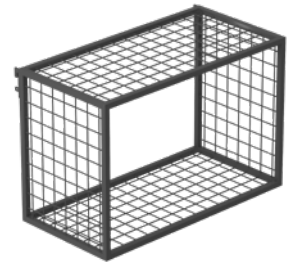

AC 03 - 6040 / P1
9040 / P1

PROFILE FRAMED BOX SHELF
WITH GRID METAL

Materials :
metal

Dimensions :
600 x 300 x 400 mm
900 x 300 x 400 mm



AC 21 - 6030 / SO
9030 / SO

COVER FOR BELT

Materials :
melamine faced mdf

Dimensions :
600 x 150 x 300 mm
900 x 150 x 300 mm



AC 04 - 6040 / SO
9040 / SO

BOX SHELF

Materials :
melamine faced mdf

Dimensions :
600 x 300 x 400 mm
900 x 300 x 400 mm



AC 05 - 6040 / SO
9040 / SO

ANGLED BOX SHELF
WITH MESH METAL

Materials :
melamine faced mdf

Dimensions :
600 x 130 x 400 mm
900 x 130 x 400 mm



AC 06 - 6040 / SO
9040 / SO

ANGLED BOX SHELF
WITH DIVIDER

Materials :
melamine faced mdf

Dimensions :
600 x 130 x 400 mm
900 x 130 x 400 mm



AC 07 - 6040 / SO
9040 / SO

BOX SHELF WITH DIVIDER

Materials :
melamine faced mdf

Dimensions :
600 x 100 x 400 mm
900 x 100 x 400 mm

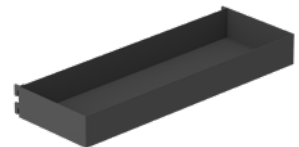

AC 13 - 6070 / P1
9070 / P1

SHEET METAL BASKET

Materials :
metal

Dimensions :
600 x 200 x 70 mm
900 x 200 x 70 mm



AC 31 - 7070 / so

CROWN PROFILE

Materials :
solid wood

Dimensions :
70 x 70 x 1000 mm



AC 32 - 7040 / so

ANGLED FRAME PROFILE

Materials :
solid wood

Dimensions :
70 x 43 x 1000 mm



AC 11 - 3550 / so

WOODEN BOX

Materials :
melamine faced mdf

Dimensions :
350 x 500 x 80 mm



AC 12 - 3550 / so

WOODEN BOX WITH DIVIDER

Materials :
melamine faced mdf

Dimensions :
350 x 500 x 80 mm

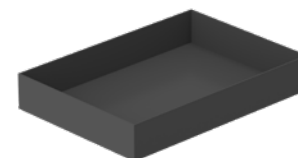

AC 11 - 3550 / p1

SHEET METAL BOX

Materials :
metal

Dimensions :
350 x 500 x 80 mm

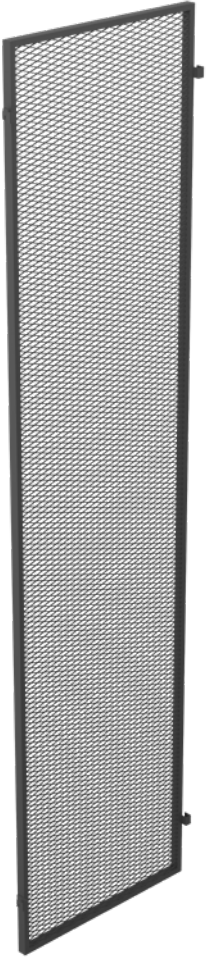

AC 41 - 60240 / P1
60270 / P1
60300 / P1

90270 / P1
90300 / P1
90300 / P1

MESH METAL
SEPERATOR PANEL

Materials :
metal

Dimensions :
563 x 2400 mm
563 x 2700 mm
563 x 3000 mm

863 x 2400 mm
863 x 2700 mm
863 x 3000 mm

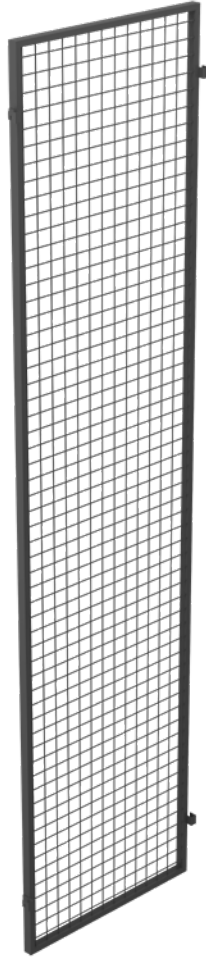

AC 42 - 60240 / P1
60270 / P1
60300 / P1

90270 / P1
90300 / P1
90300 / P1

GRID METAL
SEPERATOR PANEL

Materials :
metal

Dimensions :
563 x 2400 mm
563 x 2700 mm
563 x 3000 mm

863 x 2400 mm
863 x 2700 mm
863 x 3000 mm



AC 44 - 60240 / P1
60270 / P1
60300 / P1

VINTAGE METAL
SEPERATOR PANEL

Materials :
metal

Dimensions :
563 x 2400 mm
563 x 2700 mm
563 x 3000 mm



AC 46 - 60240 / P1
60270 / P1
60300 / P1

VINTAGE SEPERATOR WITH
POLYCARBON PANEL

Materials :
aluminium & polycarbon

Dimensions :
563 x 2400 mm
563 x 2700 mm
563 x 3000 mm

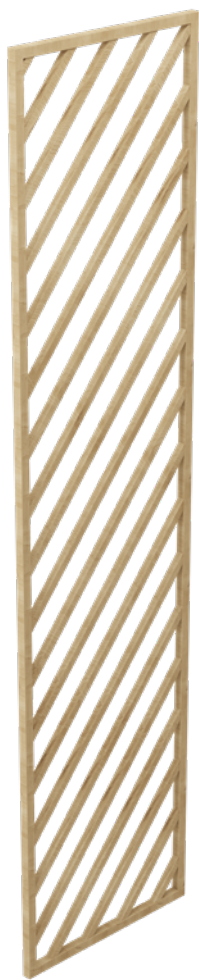

AC 47 - 60240 / SO
 60270 / SO
 60300 / SO

 90270 / SO
 90300 / SO
 90300 / SO

SOLID WOOD DIAGONAL
 SEPERATOR PANEL

Materials :
 solid wood

Dimensions :
 563 x 2400 mm
 563 x 2700 mm
 563 x 3000 mm

863 x 2400 mm
 863 x 2700 mm
 863 x 3000 mm



AC 43 - 6060 / P1
 6090 / P1
 9090 / P1

ROD METAL
 SEPERATOR PANEL

Materials :
 metal

Dimensions :
 563 x 563 mm
 563 x 863 mm
 863 x 863 mm



AC 51 - 6060 / P1
 6090 / P1
 60120 / P1
 9090 / P1
 90120 / P1
 120120 / P1
 60240 / P1
 90240 / P1

ALUMINIUM FRAMED
 VISUAL INCLUDED FABRIC -
 WITH LIGHT

Materials :
 aluminium & fabric & led

Dimensions :
 600 x 600 x 45 mm
 600 x 900 x 45 mm
 600 x 1200 x 45 mm
 900 x 900 x 45 mm
 1200 x 900 x 45 mm
 1200 x 1200 x 45 mm
 600 x 2400 x 45 mm
 900 x 2400 x 45 mm



AC 52 - 6060 / P1
 6090 / P1
 60120 / P1
 9090 / P1
 90120 / P1
 120120 / P1
 60240 / P1
 90240 / P1

ALUMINIUM FRAMED
 VISUAL INCLUDED FABRIC -
 WITHOUT LIGHT

Materials :
 aluminium & fabric

Dimensions :
 600 x 600 x 45 mm
 600 x 900 x 45 mm
 600 x 1200 x 45 mm
 900 x 900 x 45 mm
 1200 x 900 x 45 mm
 1200 x 1200 x 45 mm
 600 x 2400 x 45 mm
 900 x 2400 x 45 mm

XINT
DENIM INDUSTRY

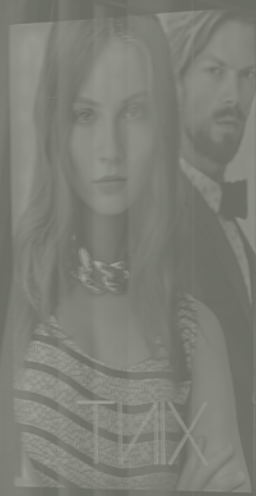

DENIM INDUSTRY

CASH DESKS

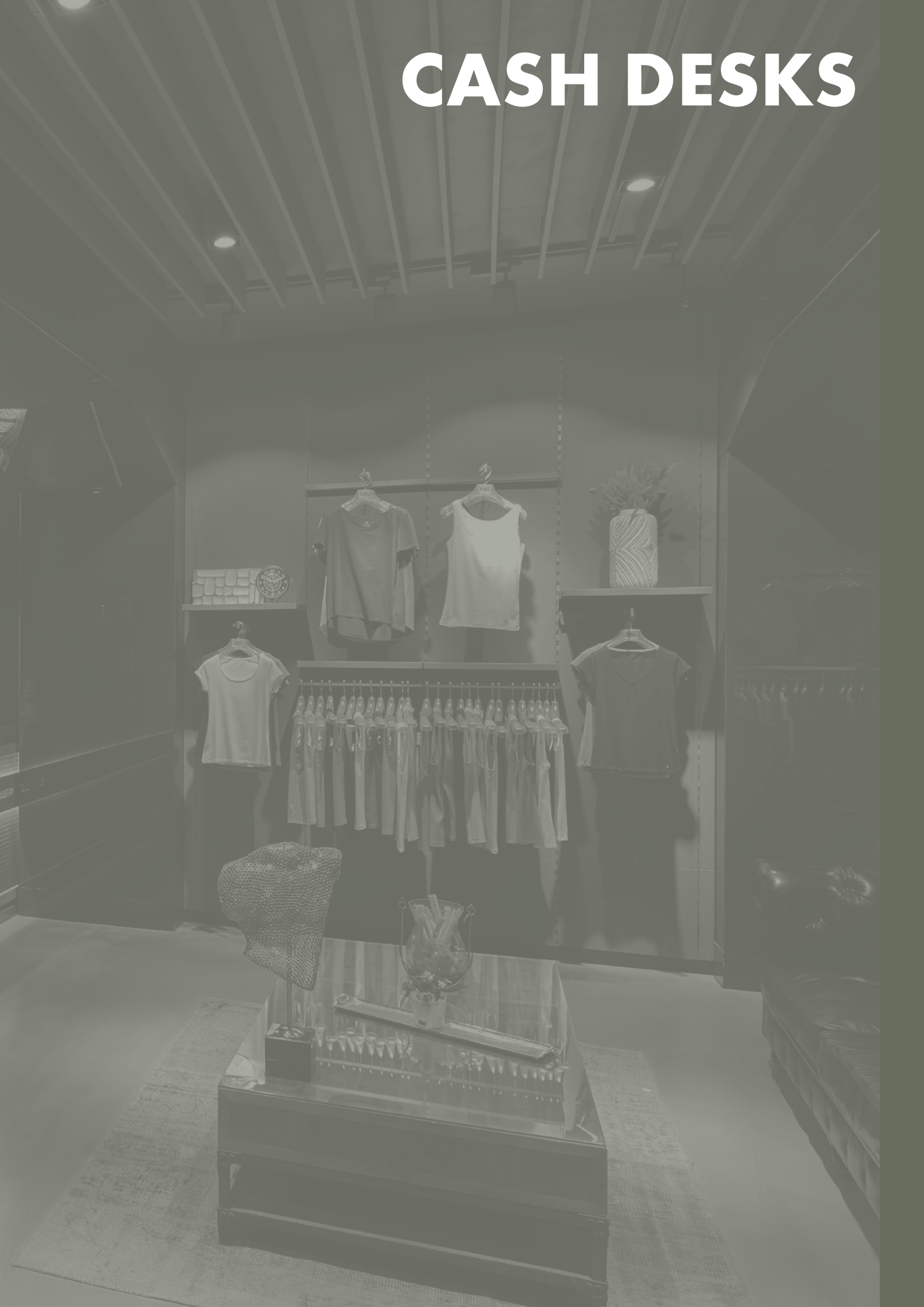



CD 01 - 1250 / ss
1600 / ss

CASH DESK

Materials :
melamine faced mdf

Dimensions :
1250 x 1100 x 800 mm
1600 x 1100 x 800 mm



CD 02 - 1500 / ss
2000 / ss
2400 / ss

CASH DESK

Materials :
melamine faced mdf

Dimensions :
1500 x 1100 x 800 mm
1980 x 1100 x 800 mm
2455 x 1100 x 800 mm



CD 03 - 1500 / P1 - SO
2000 / P1 - SO
2400 / P1 - SO

CASH DESK

Materials :
metal & melamine faced mdf

Dimensions :
1500 x 1100 x 800 mm
1980 x 1100 x 800 mm
2455 x 1100 x 800 mm



CD 21 - 1290 / so

CASH DESK AREA LOGO BOARD
WITHOUT LOGO

Materials :
melamine faced mdf

Dimensions :
1200 x 900 x 100 mm



CD 11 - 1200 / ss
1600 / ss
2000 / ss
2000 / ss

CASH DESK REAR UNIT

Materials :
melamine faced mdf

Dimensions :
1205 x 900 x 450 mm
1610 x 900 x 450 mm
2010 x 900 x 450 mm
2415 x 900 x 450 mm



CD - SU1 / P1 - SO

CASH DESK SINGLE UNIT

Materials :
metal & melamine faced mdf

Dimensions :
450 x 450 x 520 mm



CD - MU1 / SS

CASH DESK UNIT

Materials :
melamine faced mdf

Dimensions :
479 x 600 x 818 mm



CD - MU2 / SS

CASH DESK UNIT

Materials :
melamine faced mdf

Dimensions :
479 x 600 x 818 mm



CD - MU3 / SS

CASH DESK UNIT

Materials :
melamine faced mdf

Dimensions :
479 x 600 x 818 mm



CD - MS1 / SS

CASH DESK UNIT SHELF

Materials :
melamine faced mdf

Dimensions :
480 x 600 mm



CD - MU4 / SS

CASH DESK UNIT

Materials :
melamine faced mdf

Dimensions :
479 x 600 x 818 mm



CD - MU5 / SS

CASH DESK UNIT

Materials :
melamine faced mdf

Dimensions :
479 x 600 x 818 mm



CD - MU6 / SS

CASH DESK UNIT

Materials :
melamine faced mdf

Dimensions :
479 x 600 x 818 mm

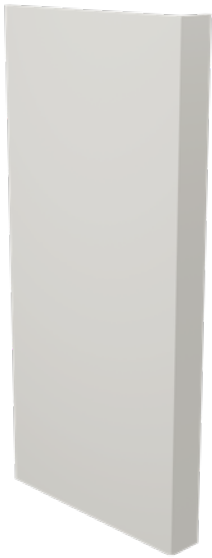

FT 01 - L2400 / SS
L2700 / SS

FITTING ROOM
LEFT SIDE PANEL

Materials :
melamine faced mdf

Dimensions :
1100 x 2400 x 180 mm
1100 x 2700 x 180 mm



FT 01 - R2400 / SS
R2700 / SS

FITTING ROOM
RIGHT SIDE PANEL

Materials :
melamine faced mdf

Dimensions :
1100 x 2400 x 180 mm
1100 x 2700 x 180 mm



FT 01 - B2400 / SS
B2700 / SS

FITTING ROOM
BACK PANEL

Materials :
melamine faced mdf

Dimensions :
1040 x 2400 mm
1040 x 2700 mm

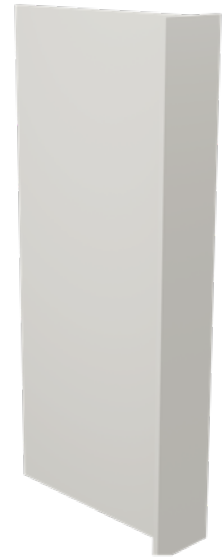

FT 01 - M2400 / SS
M2700 / SS

FITTING ROOM
LEFT SIDE PANEL

Materials :
melamine faced mdf

Dimensions :
1100 x 2400 x 360 mm
1100 x 2400 x 360 mm



FT 11 - 1040 / P1

FITTING ROOM
CURTAIN HANGER ROD

Materials :
metal

Dimensions :
1040 mm



FT 12 - 2000 / FLG
2300 / FLG

FITTING ROOM
FABRIC CURTAIN

Materials :
fabric

Dimensions :
1400 x 2000 mm
1400 x 2300 mm

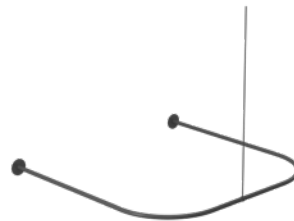

FT 13 - 1100 / P1

FITTING ROOM
CURTAIN HANGER ROD

Materials :
metal

Dimensions :
1100 x 1100 mm



FT 14 - 2300 / FLG
2600 / FLG

FITTING ROOM
DOOR FABRIC CURTAIN

Materials :
fabric

Dimensions :
1800 x 2300 mm
1800 x 2600 mm



**FT 02 - 2000 / SS
2300 / SS**

FITTING ROOM DOOR

Materials :
melamine faced mdf

Dimensions :
730 x 2000 mm
730 x 2400 mm



FT 15 - 80210 / SS

STOCK ROOM DOOR

Materials :
melamine faced mdf

Dimensions :
800 x 2100 mm

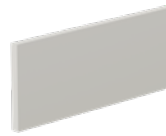

**FT 01 - F300 / SS
F400 / SS**

FITTING ROOM
FRONT CONNECTOR PANEL

Materials :
melamine faced mdf

Dimensions :
740 x 300 mm
740 x 400 mm



FT 31 - 4040 / PT - FLG

FITTING ROOM FABRIC
STOOL WITH METAL LEGS

Materials :
fabric & metal

Dimensions :
400 x 400 x 450 mm



FT 16 - 10100 / SO

FITTING ROOM
WALL COVER

Materials :
melamine faced mdf

Dimensions :
100 x 1000 mm

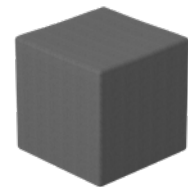

FT 32 - 4040 / FLG

FITTING ROOM
FABRIC CUBE STOOL

Materials :
fabric

Dimensions :
400 x 400 x 450 mm



FT 17 - 60200 / SO

WOODEN
FRAMED MIRROR

Materials :
mirror & melamine faced mdf

Dimensions :
600 x 2000 mm



FT 18 - 60200 / PT

ALUMINIUM
FRAMED MIRROR

Materials :
mirror & aluminium

Dimensions :
600 x 2000 mm



**FT 21 - 4015 / SO
4515 / SO**

FITTING ROOM HANGER

Materials :
metal

Dimensions :
365 x 150 mm
465 x 150 mm





FT 33 - 400 / FLG









FITTING ROOM
FABRIC CYLINDER STOOL

Materials :
fabric

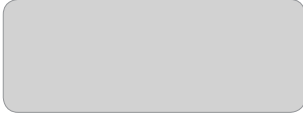
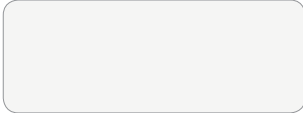
Dimensions :
Ø 400 x 450 mm

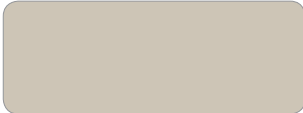
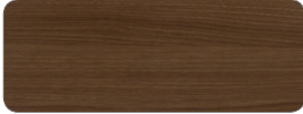
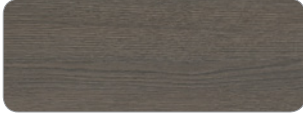
TYPE	COLOR	CODE	COLOR
ALUMINIUM		A1	matte anodized
METAL VARNISH		V1	V998 EP colored varnish
METAL POWDER COATED		P1	G853 TEX antracite
		P2	RAL 9016 traffic white
		P3	S 307 gold
		P4	RAL 3001 signal red
		P5	RAL 1023 traffic yellow
		P6	RAL 1035 pearl beige
		P7	RAL 9005 jet black
METAL SPECIAL COATED	special	SX	RAL special ral color
FABRIC		FAN	leton 620
		FGR	leton 615
		FLG	leton 602
	special	FSC	special fabric

COLOR OPTIONS

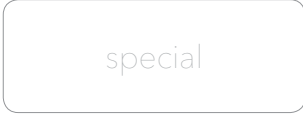
TYPE	COLOR	CODE	COLOR
MELAMINE PLAIN COLORS		BL	black
		AN	antracite
		GR	grey
		WH	white
		LN	luna
		SS	sand stone
MELAMINE WOOD PATTERN		ML	milano
		AO	antracite oak
		SM	sümela
		KR	karya
		SO	sapphire oak
		AW	antique white
MELAMINE SPECIAL COLOR & PATTERN		SW	special color & pattern

Shopline reserves the right to make changes to its products without any prior notice.
 Shopline cannot be held responsible for typographical errors in this catalog and any color differences caused by printing.
 Shopline reserves the right to make design, pattern, and color changes to its products.

MEET OUR PROFESSIONALS & EXPERTS

All the designs, projects and photos will impress you. But nothing is better than touching the actual product. Experiencing Shopleveline quality in the showroom, perhaps trying to assemble a product will be the final step for you to be convinced.





”

We Work Together to
Create Solution for Your Business

SHOPLINE SHOPFITTING SHOWROOM

Concept for Stores

Shopline created a standard, elegant, easy-to-assemble, modular, aesthetic and affordable shopfitting collection including wall units, display stands, cash desk, fitting rooms and all other accessories and components necessary to create a retail atmosphere. Thanks to its modularity, ShopLine systems and stands are delivered in flat packs. All products have assembly diagrams and videos so that customers can easily install them without requiring any professional support. Moreover, ShopDesigner, the 3D shop design software created and developed by Shopline, permits 3D designs of any store with the minimum effort within a few hours.



Designs & Concept

Rich design library for every Shopline system makes it easier to communicate and share ideas with our customer. They won't need to imagine how will it look when it's done thanks to our photorealistic visuals.

Designs & Application

Concepts that are created after perceiving the customer's goal are another part of our reliable services, which always guarantee results with realistic presentation techniques.

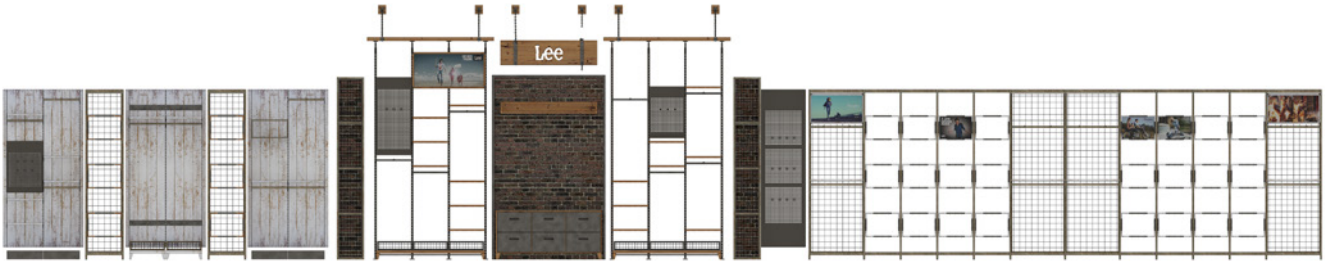
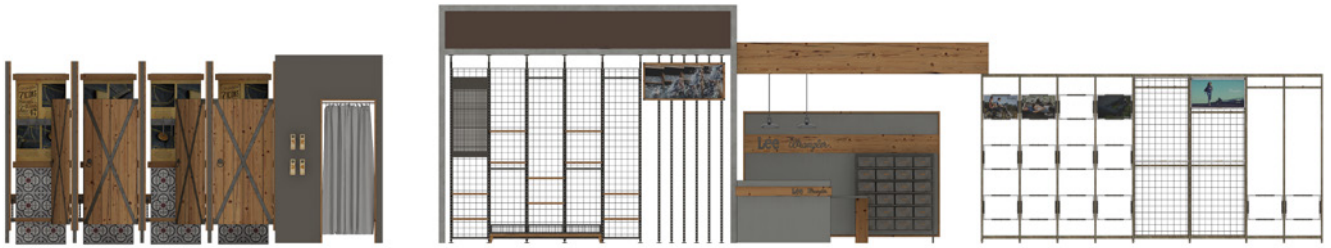

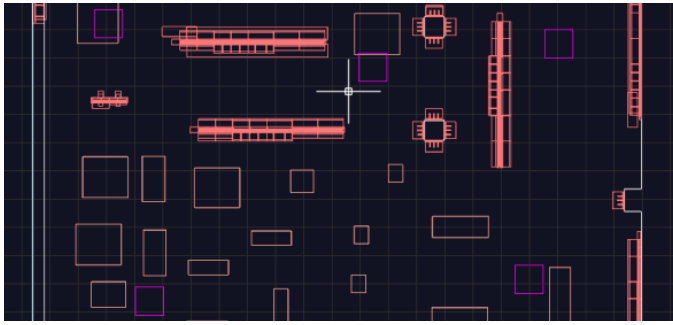

In Shop Designer, you can easily draw plans and create both 2D and 3D images of your store structure at the same time.

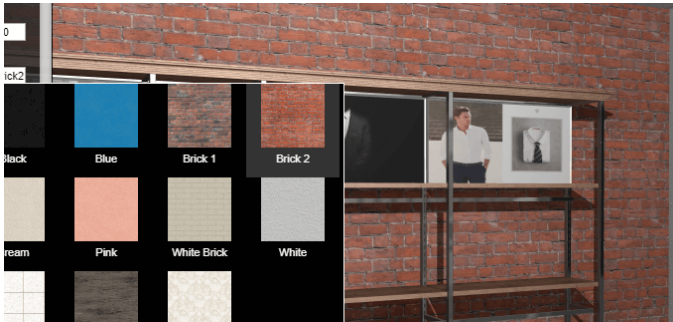

When in the 3D scene, you can use any of the wall and floor covering or materials that are already in the library or try the ones you have installed yourself. You are free to adjust the lighting as you wish as well.

You can design your store using Shoplevel's categorized products. It is possible for you to obtain the desired image for your store by using variations available even though all products are standardized.

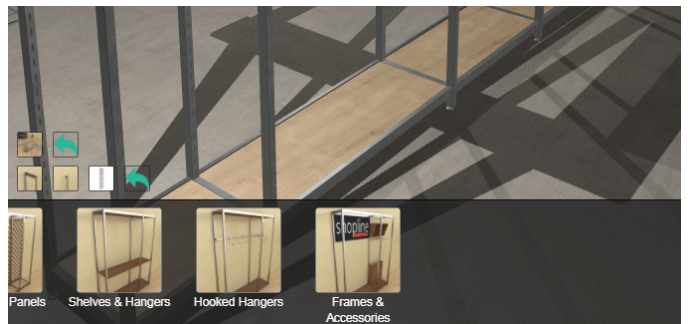

You can easily place the profiles, shelves, hangers, and other accessories in the right positions. Shop Designer knows which elements can be installed on which products and can guide you.

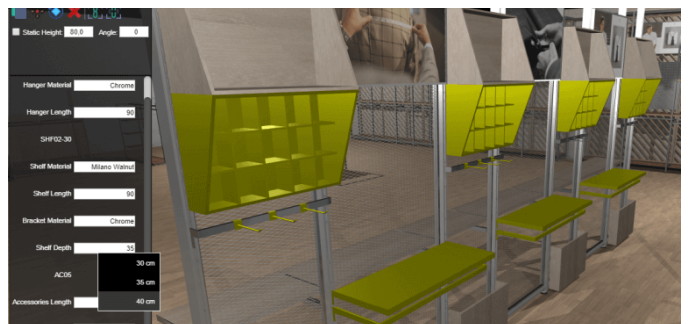

Display stands are standardized; however, it is possible to optimize the units with your desired choice of metal and wood coatings and finishes. There are wider options available for some of the display units and cash counters.

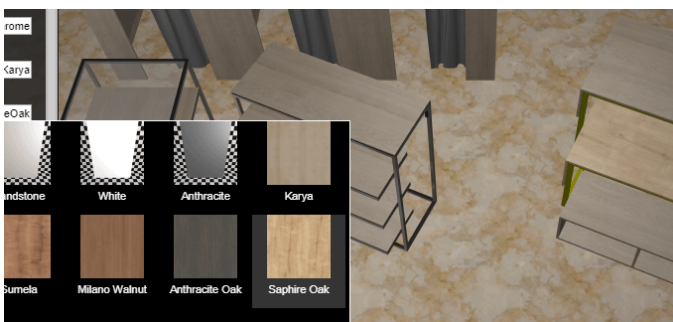

Once you have designed and furnished your store with Shoplevel products, you can obtain the cost of each product in a price list provided by Shop Designer. Then, it is possible for you to revise your design to achieve the most suitable budget.

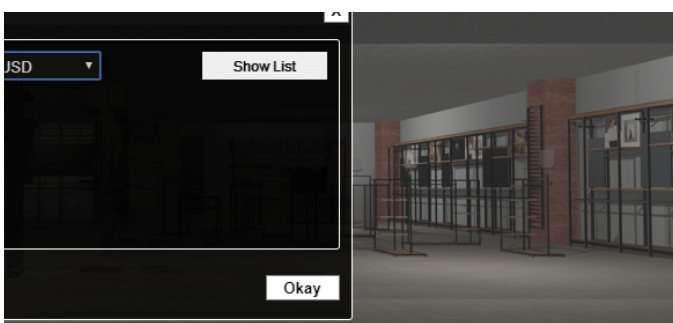

Shop Designer

One of Shoptline's biggest advantages is our custom built software Shop Designer™. You won't need any modelling skills or high-end softwares to prepare designs or quotations to your customers.

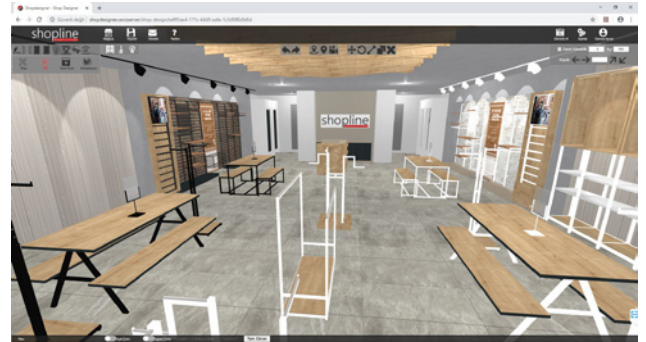
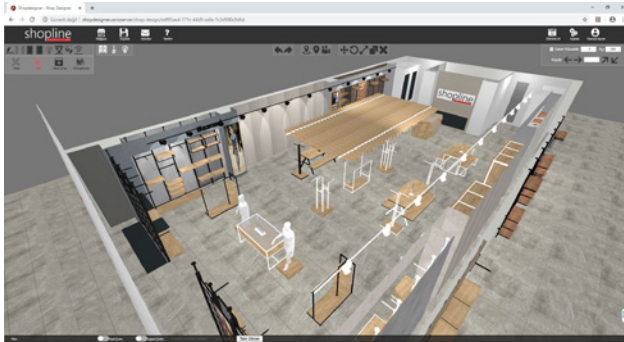

- Simple 2D CAD style layout drawing.
- 3D navigation screen.
- All Shoptline units, display stands, systems, shelves, equipments are in the library.
- Drag and drop unit placement from library with thumbnails.
- Snap placement for units. This way you can't place objects on to wrong slots.
- Color/material selections for units, walls and grounds.
- Custom texture import option.
- Screenshot utility.
- One click quotation and ability to export Excel file.

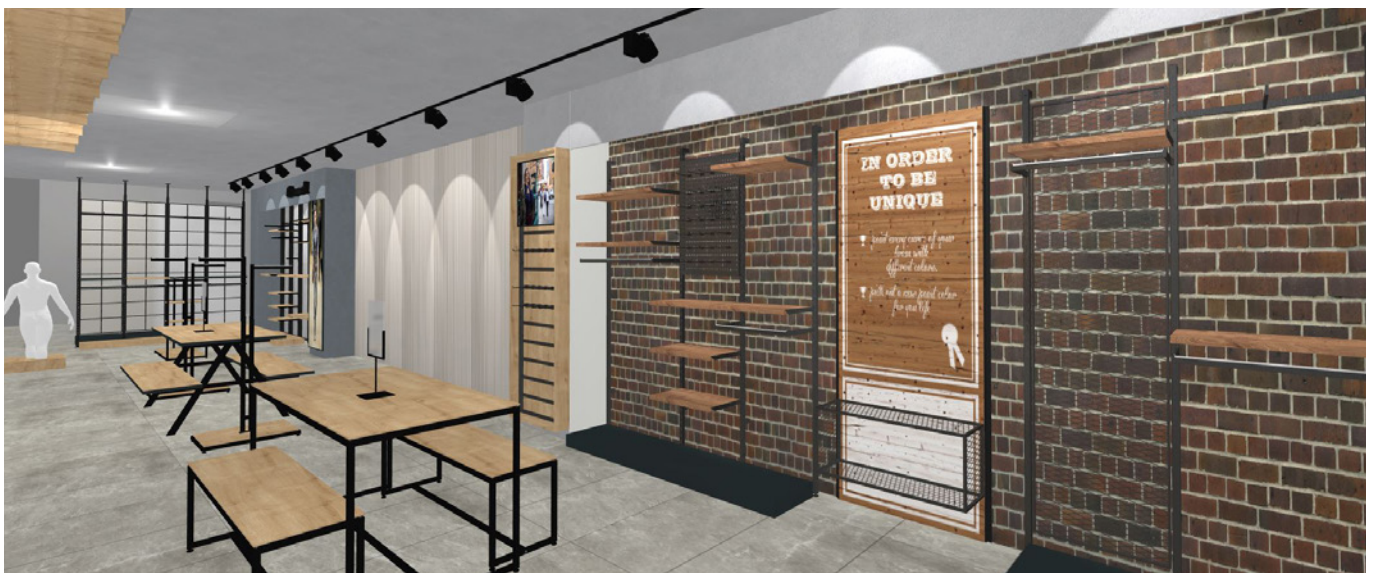









GERMANY DUBAI RUSSIA SA RIPLEY CHILE
TURKEY SWITZERLAND ALG BRAND & BRAND
FRANCE SAUDI ARABIA MALTA GEO ROOKIE
ITALY BULGARIA SPAIN DUBAI CLIMBER BC
RUSSIA ALGERIA NORWAY ITALY KANZ SHOES
UKRAINE GEORGIA TURKMENISTAN CABANI
POLAND ITALY TURKEY GERMAY DEF SHOP
NORWAY FRANCE ROMANIA TURKEY IRA XINT
NETHERLANDS MOROCCO FRANCE LIB STEIFF
SLOVAKIA GERMANY ROMANIA PM GALLERY
TURKEY RUSSIA NETHERLANDS CHILE BREEZY
GEORGIA LIBYA TUNUSIA UKR ASMC BERLIN
BULGARIA ITALY SAUDI ARABIA NETHERL KANZ
KAZAKHSTAN FRANCE NORWAY TU BAMBOO
TURKMENISTAN CROA SONS AND DAUGHTERS
IRAN SWITZERLAND DUBAI ROMANIA MARINA
IRAQ GERMANY FRANCE TUNUSIA MAICOM
ALGERIA NETHERLANDS ITALY POLAND FARGO
MOROCCO KOSOVO ROMANIA SWITZ CINICI
SPAIN AUSTRIA BULGARIA GEORGIA KOTON
UKRAINE NETHERLANDS GERMANY MATMAZEL
TUNUSIA FRANCE UNITED KING IRISH CRAFTS
CROATIA UKRAINE BULGARIA ROSA BELLA
ROMANIA MOROCCO ALGERIA IRAN IRAQ LOFT
BELARUS KYRGYZSTAN ITALY ZONE SPORT
GERMANY DUBAI POLAND BEYMEN OUTLET
TURKEY SWITZERLAND BULGARI CORSO ITALIA
FRANCE SAUDI ARABIA BELARUS VOLKS SPORT

shopline

SHOPFITTING

“More than 28 Years of Experience ”

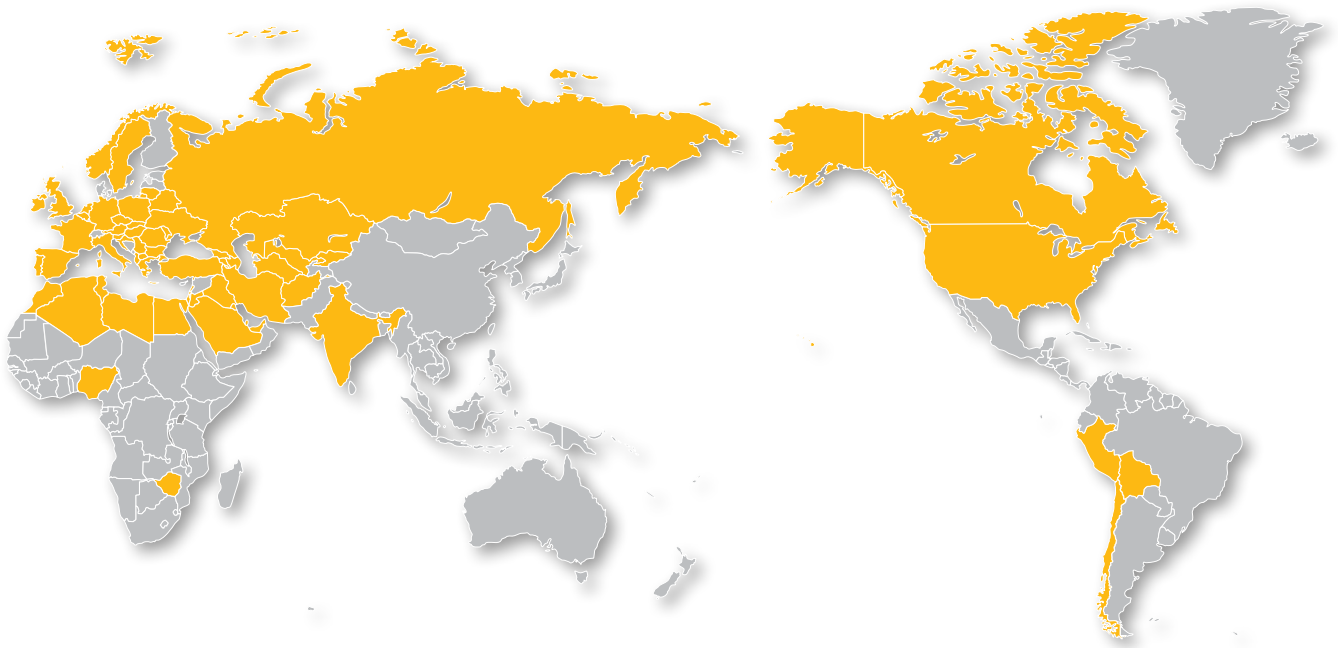

more than 60 Countries

ShoLine Shopfitting grows each day by developing with the power from its past experiences and provides innovation to its customers each step of the way to the success.

shopline

SHOPFITTING

FACTORY & HEAD OFFICE

Address : Ömerli Mah. Ilgaz Sok. No:12 34555 Istanbul TURKEY

Phone : +90 (0) 212 798 32 90

Fax : +90 (0) 212 798 32 94

SHOWROOM

Address : Im Taubental 9-11 in 41468 Neuss GERMANY

Phone : +49 (0) 2131 31 93 930

Fax : +49 (0) 2131 31 93 934

BRANCH

Address : Otto Hahn Str. 17 in 63303 Dreieich GERMANY

Phone : +49 (0) 6103 70 66 500

Fax : +49 (0) 6103 70 66 502



www.shopline.com.tr